

**Catalogue
Cast-in Channel
Systems**

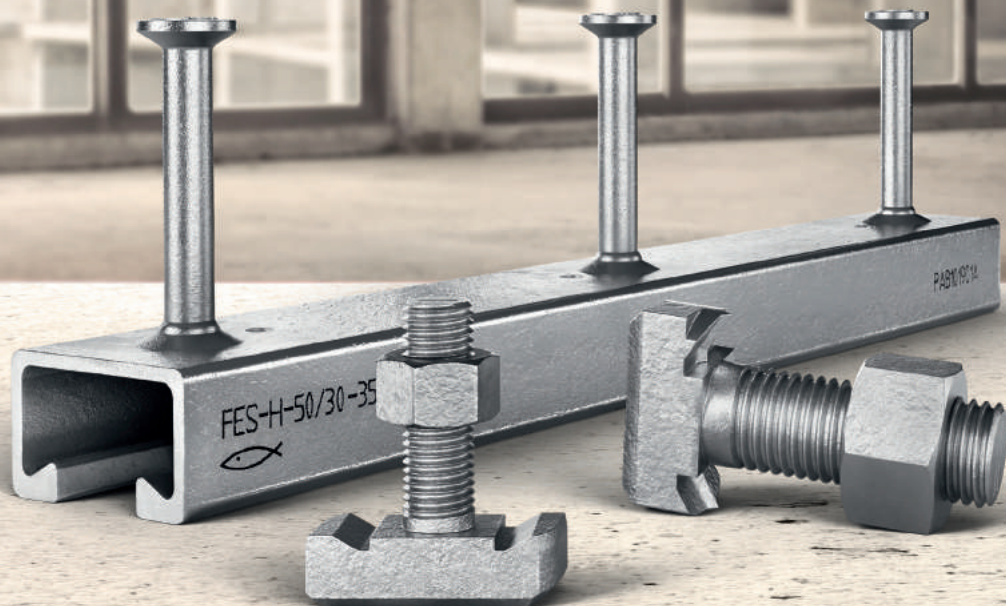

“Innovative strength and technological competence strengthen our position at market.”



Foreword

Dear fischer customers and partners,

As a leading supplier of secure and economic construction fixings, the fischer Group of Companies is shaping the future of the fixings industry. We have developed trends, such as advancing digitalisation or Building Information Modelling, into solutions for the buildings of the future. Increasing demands on planning security are changing the requirements placed on fixing technology.

Our innovative Cast-In Channel Systems provides answers to these new conditions. Our portfolio comprises fischer FES C cold-formed and FES H hot-rolled channels in a hot-dip galvanised variant. We have directly incorporated our Cast-In Channel Systems into the fischer FIXPERIENCE design software platform to enable simple calculations. Our holistic approach guarantees the highest level of safety and cost efficiency. Our preinstalled anchor significantly reduces the total operating costs when combined with Building Information Modelling. The fischer Cast-In Channel Systems achieve this thanks to the low follow-on costs with every additional fixing. Its simple installation no longer requires time- and energy-consuming drilling in challenging circumstances such as heavily reinforced

concrete. With no drill dust and without requiring heavy machinery, the fischer Cast-In Channel Systems offers further advantages in terms of health and safety and environmental management – advantages which are noticeable from the very first application.

As the market leader for fixing systems we are shaping the buildings of the future on the construction sites of the present. Discover the advantages of the fischer Cast-In Channel Systems in our catalogue!

Dr. Oliver Geibig

Managing Director Business Units & Engineering



“Whoever chooses fischer receives more than a range of safe products. The aim is to always develop the best solutions for our customers across the globe.”

Besides the innovative products, this predominantly concerns support that is focused on the customer, and services designed to improve customer benefit.

A brand and its promise to perform.

Continious improvement

The fischer ProzessSystem (fPS) we ensure that we are adapting and optimising our processes in line with customer requirements in a flexible manner and on a continuous basis. Thus we are glad having been awarded with the 1. place “Excellence in Operations” within the challenging contest “Factory of the Year”.



Award 2015
Excellence in
Operations

Safety that connects. Decisive quality.

We don't make any compromises when it comes to the safety of our products. A whole host of our products are distinguished by comprehensive, up-to-date and international approvals. The fischer product range is wellpositioned in all sectors of fixing technology – Steel, Nylon and Chemical fixings. In awardwinning quality which continues to impress both professional clients and private customers with equal measure.



See ICC-ES
Evaluation Report
at www.icc-es.org



International approvals characterise many of our products.

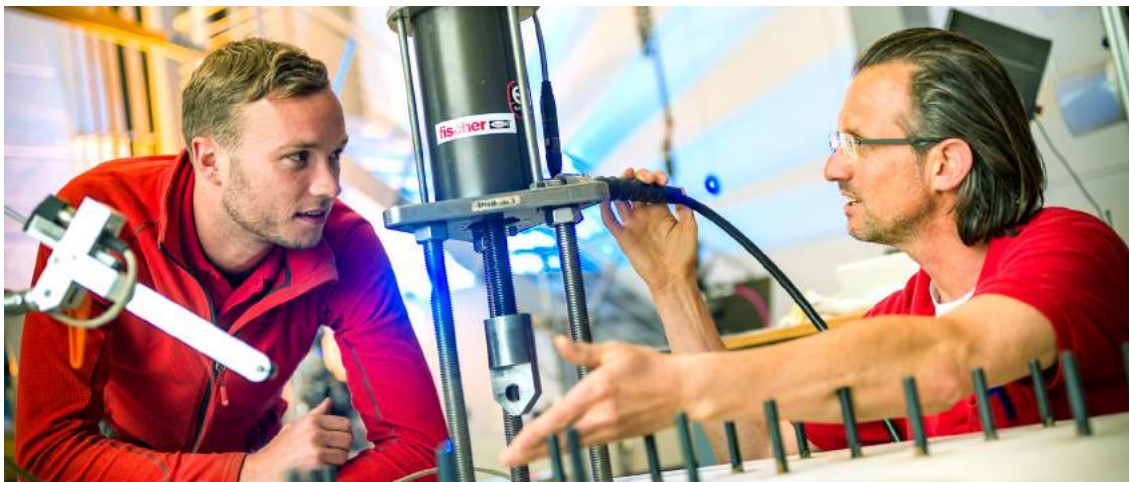



Always on the pulse of time

At fischer, innovation is more than just a sum of the patents. We are open to new things and are prepared for change – always with the aim of offering our customers the greatest possible benefits. Over the years, our own development and production sites have been developing numerous fixing solutions for the most wide-ranging applications. Be it new production procedures or materials, such as renewable raw materials: We are carrying out the research for your safety and will continue to do so in the future. This gives us such great flexibility that we can even develop tailor-made customer solutions. This power to innovate has seen fischer become market leader in anchor technology and the fixing industry.

Our service to you

We are a reliable partner, one that will stand at your side and address your individual requirements with advice and action:

- Our products range from chemical systems to steel anchors through to plastic anchors.
- Competence and innovation through own research, development and production.
- Global presence and active sales service in over 100 countries.
- Qualified technical consulting for economical and compliant fastening solutions. Also on-site at the construction site requested.
- Training sessions, some with accreditation, at your premises or at the fischer academy.
- Design and construction software for demanding applications.

We take responsibility

Our active environment management policy means that we are helping to maintain an intact environment for our generation and for those that follow. The environment management policy at the Tumlingen site has been certified in line with DIN EN ISO 14001.

It fills us with particular pride that in 2020 we have received the most important and largest award in Europe in the field of sustainability: the German Sustainability Award - category large companies.

This was in recognition of our holistic approach and the strategic anchoring of our sustainability management. With our greenline products we have launched the first range of fixings on the market that is based on renewable raw materials to more than 50%.



Greenline assortment based on 50% regrowing raw materials



German Sustainability Award



H&M

Downtown · Auckland · New Zealand

Innovations that inspire professionals.

Content

Introduction	8	Chapter	1
Channels	16	Chapter	2
Bolts	30	Chapter	3
Basics	44	Chapter	4
Service	54	Chapter	5



1

1

Introduction

Channel nomenclature	10
T-Bolt nomenclature	11
Product portfolio	12
Typical application	15

Channel nomenclature.

1

FES-H-S-I-52/34-III-HDG (-rxxxx)

Fischer Einlege Schiene
(fischer Cast-in Channel)

C - Cold formed
H - Hot rolled

I-anchor (if applicable)
Note: Round anchors are considered standard and go without special abbreviation in the product naming.

52 Width: 52 mm

34 Height: 34 mm

III Length [mm]

HDG Coating HDG: >50 µm

For curved channels only: r [mm]



Example standard plain channel.

FES-C-49/30-300-HDG for:

- Cold formed
- Round anchors
- HDG >50µm



Cold formed Cast-in Channel Systems

Economical cold-formed Cast-in Channels combining high loading capacity and safety.

- Two directional load capacity: tension and shear perpendicular to the channel axis.
- Ideal prepositioned fixing solution, capable of covering on-site tolerances.
- Suitable for applications in cracked and non-cracked concrete.
- Permanently adjustable fixing solution.



Non-serrated hot rolled Cast-in Channel Systems

Hot-rolled Cast-in Channels combining excellent load capacity with high safety and flexibility.

- All directional load capacity.
- Fundamental load capacity in longitudinal direction in combination with channel bolts FBC-N.
- Ideal prepositioned fixing solution, capable of covering on-site tolerances.
- Suitable for applications in cracked and non-cracked concrete.
- Permanently adjustable fixing solution.



Serrated hot rolled Cast-in Channel Systems

Hot-rolled Cast-in Channels combining optimum load capacity with high safety

- All directional load capacity. Excellent loading capacity in longitudinal direction in combination with FBC-S due to the full serration of the system.
- Ideal prepositioned fixing solution, capable of covering on-site tolerances.
- Suitable for applications in cracked and non-cracked concrete.
- Permanently adjustable fixing solution.

T-bolt nomenclature.

FBC-N-50/30-MddxIII-s.s HDG

Fischer Bolt Channel

S Serrated (if applicable)
N Notched (if applicable)

Fits to channel profiles
50/30, 52/34

Metric

Diameter [mm]

Length [mm]

Steel grade
e.g. 8.8

Coating
e.g. HDG

Example notched T-bolt

FBC-N-50/30-M20x80-8.8-HDG for:

- Notched T-bolt
- Applicable in combination with FES-H-50/30 and FES-H-52/34 channels
- Size: M20x80
- Steel grade: 8.8
- HDG >50µm

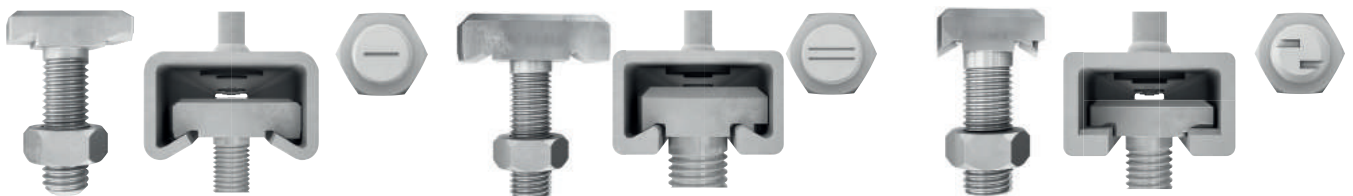
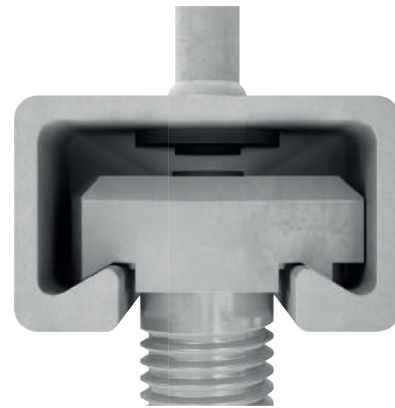

Standard channel bolt

Cast-in Channel System with smooth surface of the channel lips in combination with a smooth surface on the underside of the channel bolt head.

- Two directional load capacity
- Marked on bolt tip with one groove
- Steel grade: 8.8

Notched channel bolt







Cast-in Channel with smooth surface of the channel lips in combination with a notching channel bolt.

- Only for hot-rolled profiles without teeth
- All directional load capacity
- Fundamental load capacity in channel longitudinal direction provided
- Marked on bolt tip with paralleled two grooves
- Steel grade: 8.8

Serrated channel bolt

Cast-in Channel with serrated channel lips in combination with locking channel bolts with matching serrations on the channel bolt head.

- Only for hot-rolled profiles with teeth
- All directional load capacity
- Qualified load capacity in channel longitudinal direction to prevent bolt slide risks
- Marked on bolt tip with staggered two grooves
- Steel grade: 8.8

Profile		Non-serrated channels					
		FES-H-I-52/34	FES-H-52/34	FES-C-54/33	FES-H-I-50/30	FES-H-50/30	FES-C-49/30
							
Type		Hot-rolled	Hot-rolled	Cold-formed	Hot-rolled	Hot-rolled	Cold-formed
Channel bolts		FBC-50/30 FBC-N-50/30	FBC-50/30 FBC-N-50/30	FBC-50/30	FBC-50/30 FBC-N-50/30	FBC-50/30 FBC-N-50/30	FBC-50/30
Thread		M10 - M20	M10 - M20	M10 - M20	M10 - M20	M10 - M20	M10 - M20
Design resistance for connection between anchor and channel	$N_{Rd,s,c}$ [kN]	39.1	30.6	30.6	22.2	17.2	17.2
Design resistance for connection between anchor and channel	$N_{Rd,s,c,y}$ [kN]	55.6	55.6	30.6	33.3	33.3	17.2
Design resistance for connection between anchor and channel	$N_{Rd,s,c,x}$ [kN]	23.4	18.3	–	13.3	10.3	–
Design resistance for lip failure of channel	$N_{Rd,s,l}$ [kN]	40.0	40.0	30.6	23.9	23.9	17.2
Design resistance for lip failure of channel	$N_{Rd,s,ly}$ [kN]	55.6	55.6	30.6	33.3	33.3	17.2
Design resistance for lip failure of channel	$N_{Rd,s,lx}$ [kN] (γ_{inst} included)	7.4	7.4	–	7.4	7.4	–
Dimension of anchor channel	b_{ch} [mm]	52.5	52.5	53.5	50	50	50
Dimension of anchor channel	h_{ch} [mm]	34	34	33	30	30	30
Dimension of anchor channel	d_{ch} [mm]	22.5	22.5	21.5	22.5	22.5	22
Dimension of anchor channel	f [mm]	11.5	11.5	7.5	8.1	8.1	7
Dimension of anchor channel	$h_{nom,min}$ [mm]	160	160	157.5	99	96.2	96.2
Dimension of anchor channel	$h_{ef,min}$ [mm]	155	155	155	94	94	94
Approvals/assessments		ETA	ETA	ETA	ETA	ETA	ETA

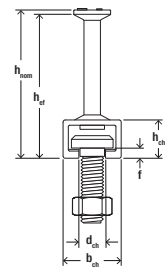

1

FES-H-I-40/22	FES-H-40/22	FES-C-40/25	FES-C-38/17	FES-C-28/15	Serrated channels	
					FES-H-S-38/23	FES-H-S-29/20
Hot-rolled	Hot-rolled	Cold-formed	Cold-formed	Cold-formed	Hot-rolled	Hot-rolled
FBC-40/22	FBC-40/22	FBC-40/22	FBC-38/17, FBC-S-38/23	FBC-28/15, FBC-S-29/20	FBC-S-38/23	FBC-S-29/20
M10 - M16	M10 - M16	M10 - M16	M10 - M16	M8 - M12	M12 - M16	M12
19.4	11.1	11.1	10.0	5.0	16.8	11.2
22.2	22.2	11.1	10.0	5.0	16.8	11.2
-	-	-	-	-	10.1	6.7
21.1	21.1	11.1	10.0	5.0	16.8	11.2
22.2	22.2	11.1	10.0	5.0	16.8	11.2
-	-	-	-	-	12.9	10.4
40	40	40	38	28	38	30
23.5	23.5	25	17.3	15.5	23	20
18	18	18	18	12	18	14
6.2	6.2	6	3	2.3	6	5.2
84	92	81	78	46.5	99.2	79.2
79	90	79	76	45	97	77
ETA	ETA	ETA	ETA	ETA	ETA	ETA



Typical applications

Commercial and residential buildings

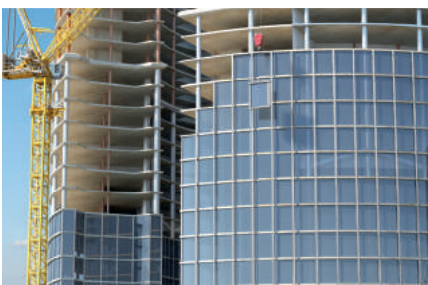

- Façade
- Elevators fastening
- MEP applications

Industrial and power facilities

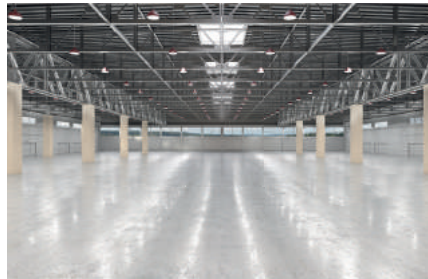

- Façade
- Machine and shelf fastening
- MEP applications
- Elevators fastening

Subway and railway construction



- MEP applications
- Traffic signs fastening
- Evacuation platform fastening

Road & bridge construction



- MEP applications
- Traffic signs fastening
- Security fence fastening
- Noise & safety barrier fastening

Prefabricated concrete structure



- Various pre-cast elements
- MEP applications
- Facilities fastening

Other applications





- Stadium construction (seat fastening, fastening of precast elements & supply lines)
- Airports



2

Cast-in Channels

Content

Cast-in Channel FES-C	18	
Cast-in Channel FES-H	22	
Cast-in Channel FES-H-S	26	

Cast-in Channel FES-C

Cold-formed anchor channel. Strong and safe.



2

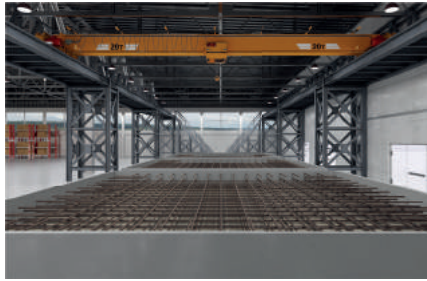

Pre-cast elements

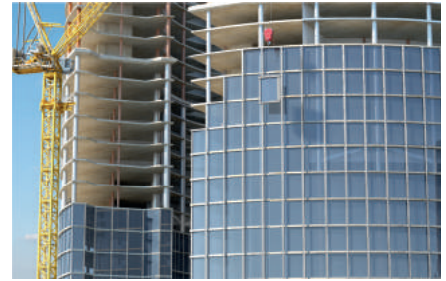

Unitised curtain wall

Applications

- Suitable for all types of buildings or structures
- Façades
- Prefabricated Elements
- Railways
- Metro tunnels and stations
- Industrial applications

Advantages

- Economical cold-formed Cast-in Channels combining high loading capacity and safety.
- Two directional load capacity: tension and shear perpendicular to the channel axis.
- Ideal prepositioned fixing solution, capable of covering on-site tolerances.
- Suitable for applications in cracked and non-cracked concrete.
- Permanently adjustable fixing solution.

Approval



ETA-18/0862, FES with special screw FBC

Building materials

Concrete C12/15 to C90/105, cracked and non-cracked

Functioning

Suitable for use in combination with plain T-Bolts FBC or serrated T-Bolts FBC-S (however with no longitudinal load capacity).

Installation FES

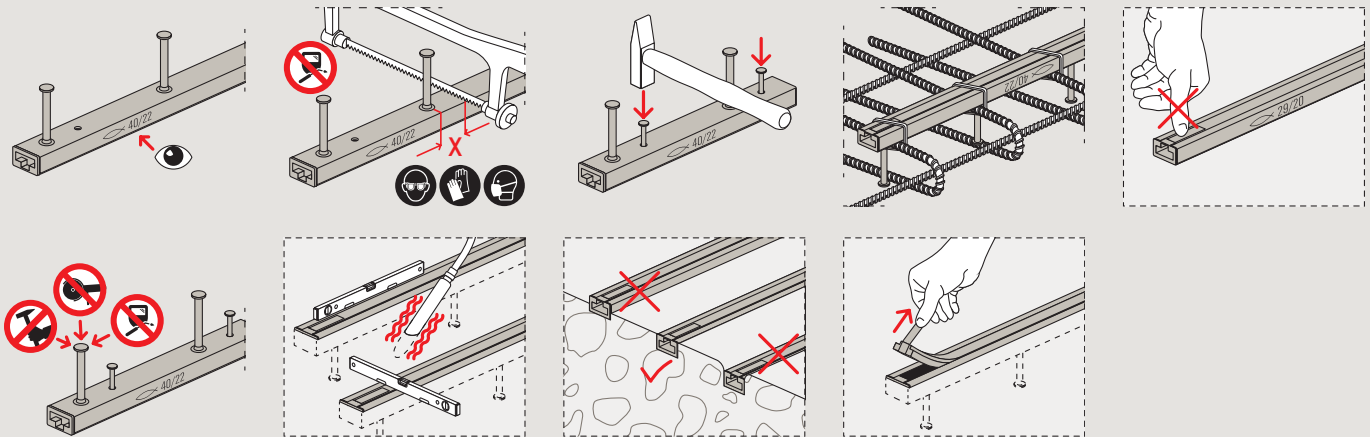

Technical data

Profile FES-C-28/15



FES-C

Item	Item no.	Approval ETA	Length l [mm]	Number of anchors	Serrated	Type	Coating	Match	Thread M	Sales unit [pcs]
FES-C-28/15-100-HDG	552543	●	100	2	No	Round anchor	hot-dip galvanised	FBC-28/15	M8 - M12	1
FES-C-28/15-150-HDG	552544	●	150	2	No	Round anchor	hot-dip galvanised	FBC-28/15	M8 - M12	1
FES-C-28/15-200-HDG	552545	●	200	2	No	Round anchor	hot-dip galvanised	FBC-28/15	M8 - M12	1
FES-C-28/15-250-HDG	552546	●	250	2	No	Round anchor	hot-dip galvanised	FBC-28/15	M8 - M12	1
FES-C-28/15-300-HDG	552547	●	300	3	No	Round anchor	hot-dip galvanised	FBC-28/15	M8 - M12	1
FES-C-28/15-350-HDG	552548	●	350	3	No	Round anchor	hot-dip galvanised	FBC-28/15	M8 - M12	1
FES-C-28/15-450-HDG	552549	●	450	3	No	Round anchor	hot-dip galvanised	FBC-28/15	M8 - M12	1
FES-C-28/15-500-HDG	552550	●	500	4	No	Round anchor	hot-dip galvanised	FBC-28/15	M8 - M12	1
FES-C-28/15-850-HDG	552551	●	850	5	No	Round anchor	hot-dip galvanised	FBC-28/15	M8 - M12	1
FES-C-28/15-1050-HDG	552552	●	1,050	6	No	Round anchor	hot-dip galvanised	FBC-28/15	M8 - M12	1
FES-C-28/15-3050-HDG	552553	●	3,050	16	No	Round anchor	hot-dip galvanised	FBC-28/15	M8 - M12	1
FES-C-28/15-6070-HDG	552554	●	6,070	31	No	Round anchor	hot-dip galvanised	FBC-28/15	M8 - M12	1

Technical data

Profile FES-C-38/17



FES-C

Item	Item no.	Approval ETA	Length l [mm]	Number of anchors	Serrated	Type	Coating	Match	Thread M	Sales unit [pcs]
FES-C-38/17-100-HDG	552555	●	100	2	No	Round anchor	hot-dip galvanised	FBC-38/17	M10 - M12	1
FES-C-38/17-150-HDG	552556	●	150	2	No	Round anchor	hot-dip galvanised	FBC-38/17	M10 - M12	1
FES-C-38/17-200-HDG	552557	●	200	2	No	Round anchor	hot-dip galvanised	FBC-38/17	M10 - M12	1
FES-C-38/17-250-HDG	552558	●	250	2	No	Round anchor	hot-dip galvanised	FBC-38/17	M10 - M12	1
FES-C-38/17-300-HDG	552559	●	300	3	No	Round anchor	hot-dip galvanised	FBC-38/17	M10 - M12	1
FES-C-38/17-350-HDG	552560	●	350	3	No	Round anchor	hot-dip galvanised	FBC-38/17	M10 - M12	1
FES-C-38/17-450-HDG	552561	●	450	3	No	Round anchor	hot-dip galvanised	FBC-38/17	M10 - M12	1
FES-C-38/17-500-HDG	552562	●	500	4	No	Round anchor	hot-dip galvanised	FBC-38/17	M10 - M12	1
FES-C-38/17-850-HDG	552563	●	850	5	No	Round anchor	hot-dip galvanised	FBC-38/17	M10 - M12	1
FES-C-38/17-1050-HDG	552564	●	1,050	6	No	Round anchor	hot-dip galvanised	FBC-38/17	M10 - M12	1
FES-C-38/17-3050-HDG	552565	●	3,050	16	No	Round anchor	hot-dip galvanised	FBC-38/17	M10 - M12	1
FES-C-38/17-6070-HDG	552566	●	6,070	31	No	Round anchor	hot-dip galvanised	FBC-38/17	M10 - M12	1

Technical data

Profile FES-C-40/25



FES-C

Item	Item no.	Approval ETA	Length l [mm]	Number of anchors	Serrated	Type	Coating	Match	Thread M	Sales unit [pcs]
FES-C-40/25-150-HDG	552567	●	150	2	No	Round anchor	hot-dip galvanised	FBC-40/22	M10 - M16	1
FES-C-40/25-200-HDG	552568	●	200	2	No	Round anchor	hot-dip galvanised	FBC-40/22	M10 - M16	1
FES-C-40/25-250-HDG	552569	●	250	2	No	Round anchor	hot-dip galvanised	FBC-40/22	M10 - M16	1
FES-C-40/25-300-HDG	552570	●	300	2	No	Round anchor	hot-dip galvanised	FBC-40/22	M10 - M16	1
FES-C-40/25-350-HDG	552571	●	350	3	No	Round anchor	hot-dip galvanised	FBC-40/22	M10 - M16	1
FES-C-40/25-400-HDG	552572	●	400	3	No	Round anchor	hot-dip galvanised	FBC-40/22	M10 - M16	1
FES-C-40/25-550-HDG	552573	●	550	3	No	Round anchor	hot-dip galvanised	FBC-40/22	M10 - M16	1
FES-C-40/25-800-HDG	552574	●	800	4	No	Round anchor	hot-dip galvanised	FBC-40/22	M10 - M16	1
FES-C-40/25-1050-HDG	552575	●	1,050	5	No	Round anchor	hot-dip galvanised	FBC-40/22	M10 - M16	1
FES-C-40/25-3050-HDG	552576	●	3,050	13	No	Round anchor	hot-dip galvanised	FBC-40/22	M10 - M16	1
FES-C-40/25-6070-HDG	552577	●	6,070	25	No	Round anchor	hot-dip galvanised	FBC-40/22	M10 - M16	1

Technical data

Profile FES-C-49/30



FES-C

Item	Item no.	Approval ETA	Length l [mm]	Number of anchors	Serrated	Type	Coating	Match	Thread l	Sales unit [pcs]
FES-C-49/30-150-HDG	552578	●	150	2	No	Round anchor	hot-dip galvanised	FBC-50/30	M10 - M20	1
FES-C-49/30-200-HDG	552579	●	200	2	No	Round anchor	hot-dip galvanised	FBC-50/30	M10 - M20	1
FES-C-49/30-250-HDG	552580	●	250	2	No	Round anchor	hot-dip galvanised	FBC-50/30	M10 - M20	1
FES-C-49/30-300-HDG	552581	●	300	2	No	Round anchor	hot-dip galvanised	FBC-50/30	M10 - M20	1
FES-C-49/30-350-HDG	552582	●	350	3	No	Round anchor	hot-dip galvanised	FBC-50/30	M10 - M20	1
FES-C-49/30-400-HDG	552583	●	400	3	No	Round anchor	hot-dip galvanised	FBC-50/30	M10 - M20	1
FES-C-49/30-550-HDG	552584	●	550	3	No	Round anchor	hot-dip galvanised	FBC-50/30	M10 - M20	1
FES-C-49/30-800-HDG	552585	●	800	4	No	Round anchor	hot-dip galvanised	FBC-50/30	M10 - M20	1
FES-C-49/30-1050-HDG	552586	●	1,050	5	No	Round anchor	hot-dip galvanised	FBC-50/30	M10 - M20	1
FES-C-49/30-3050-HDG	552587	●	3,050	13	No	Round anchor	hot-dip galvanised	FBC-50/30	M10 - M20	1
FES-C-49/30-6070-HDG	552588	●	6,070	25	No	Round anchor	hot-dip galvanised	FBC-50/30	M10 - M20	1

Technical data

Profile FES-C-54/33



FES-C

Item	Item no.	Approval ETA	Length l [mm]	Number of anchors	Serrated	Type	Coating	Match	Thread M	Sales unit [pcs]
FES-C-54/33-150-HDG	552589	●	150	2	No	Round anchor	hot-dip galvanised	FBC-50/30	M10 - M20	1
FES-C-54/33-200-HDG	552590	●	200	2	No	Round anchor	hot-dip galvanised	FBC-50/30	M10 - M20	1
FES-C-54/33-250-HDG	552591	●	250	2	No	Round anchor	hot-dip galvanised	FBC-50/30	M10 - M20	1
FES-C-54/33-300-HDG	552592	●	300	2	No	Round anchor	hot-dip galvanised	FBC-50/30	M10 - M20	1
FES-C-54/33-350-HDG	552593	●	350	3	No	Round anchor	hot-dip galvanised	FBC-50/30	M10 - M20	1
FES-C-54/33-400-HDG	552594	●	400	3	No	Round anchor	hot-dip galvanised	FBC-50/30	M10 - M20	1
FES-C-54/33-550-HDG	552595	●	550	3	No	Round anchor	hot-dip galvanised	FBC-50/30	M10 - M20	1
FES-C-54/33-800-HDG	552596	●	800	4	No	Round anchor	hot-dip galvanised	FBC-50/30	M10 - M20	1
FES-C-54/33-1050-HDG	552597	●	1,050	5	No	Round anchor	hot-dip galvanised	FBC-50/30	M10 - M20	1
FES-C-54/33-3050-HDG	552598	●	3,050	16	No	Round anchor	hot-dip galvanised	FBC-50/30	M10 - M20	1
FES-C-54/33-6070-HDG	552599	●	6,070	25	No	Round anchor	hot-dip galvanised	FBC-50/30	M10 - M20	1

2

Cast-in Channel FES-H

Hot rolled for excellent strength and safety.

2



Power plant

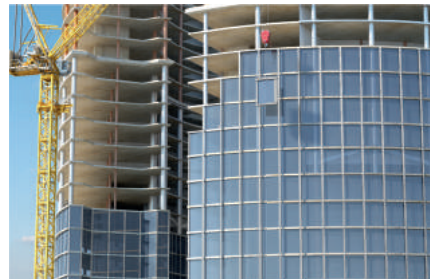

Unitised curtain wall

Applications

- Suitable for all types of buildings or structures
- Façades
- Prefabricated elements
- Railways
- Metro tunnels and stations
- Industrial applications

Advantages

- Hot-rolled Cast-in Channels combining excellent load capacity with high safety and flexibility.
- All directional load capacity.
- Fundamental load capacity in longitudinal direction in combination with channel bolts FBC-N.
- Ideal prepositioned fixing solution, capable of covering on-site tolerances.
- Suitable for applications in cracked and non-cracked concrete.
- Permanently adjustable fixing solution.

Approval



ETA-18/0862, FES with special screw FBC

Building materials

Concrete C12/15 to C90/105, cracked and non-cracked.

Functioning

Suitable for use in combination with plain T-Bolts FBC or notching T-Bolts FBC-N.

Installation FES

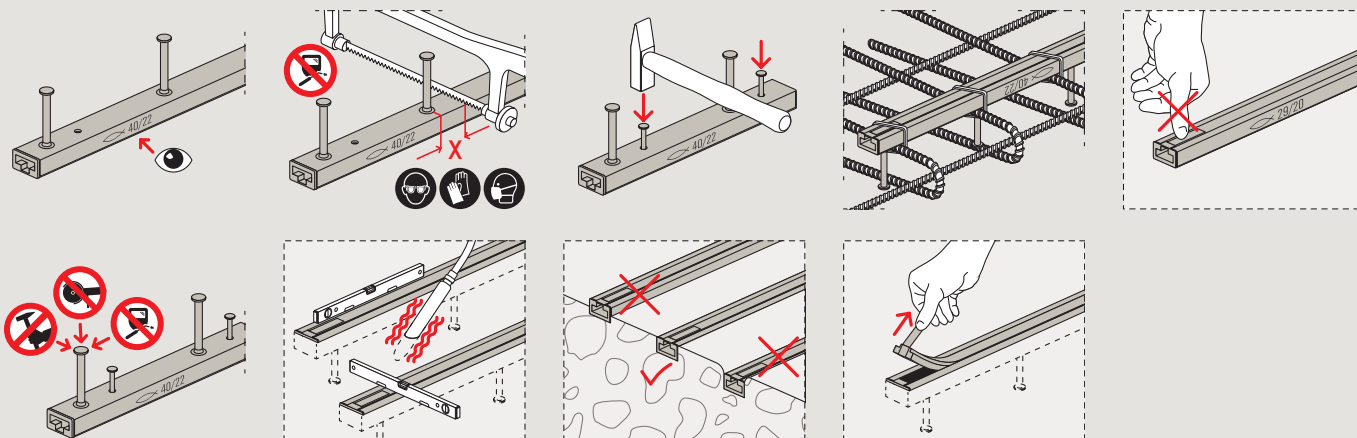

Technical data

Profile FES-H-40/22



FES-H

Item	Item no.	Approval ETA	Length l [mm]	Number of anchors	Serrated	Type	Coating	Match	Thread M	Sales unit [pcs]
FES-H-40/22-150-HDG	552468	●	150	2	No	Round anchor	hot-dip galvanised	FBC-40/22	M10 - M16	1
FES-H-40/22-200-HDG	552469	●	200	2	No	Round anchor	hot-dip galvanised	FBC-40/22	M10 - M16	1
FES-H-40/22-250-HDG	552470	●	250	2	No	Round anchor	hot-dip galvanised	FBC-40/22	M10 - M16	1
FES-H-40/22-300-HDG	552421	●	300	2	No	Round anchor	hot-dip galvanised	FBC-40/22	M10 - M16	1
FES-H-40/22-350-HDG	552472	●	350	3	No	Round anchor	hot-dip galvanised	FBC-40/22	M10 - M16	1
FES-H-40/22-400-HDG	552473	●	400	3	No	Round anchor	hot-dip galvanised	FBC-40/22	M10 - M16	1
FES-H-40/22-550-HDG	552474	●	550	3	No	Round anchor	hot-dip galvanised	FBC-40/22	M10 - M16	1
FES-H-40/22-800-HDG	552475	●	800	4	No	Round anchor	hot-dip galvanised	FBC-40/22	M10 - M16	1
FES-H-40/22-1050-HDG	552476	●	1,050	5	No	Round anchor	hot-dip galvanised	FBC-40/22	M10 - M16	1
FES-H-40/22-1300-HDG	552477	●	1,300	6	No	Round anchor	hot-dip galvanised	FBC-40/22	M10 - M16	1
FES-H-40/22-1550-HDG	552478	●	1,550	7	No	Round anchor	hot-dip galvanised	FBC-40/22	M10 - M16	1
FES-H-40/22-1800-HDG	552479	●	1,800	8	No	Round anchor	hot-dip galvanised	FBC-40/22	M10 - M16	1
FES-H-40/22-2050-HDG	552480	●	2,050	9	No	Round anchor	hot-dip galvanised	FBC-40/22	M10 - M16	1
FES-H-40/22-2300-HDG	552481	●	2,300	10	No	Round anchor	hot-dip galvanised	FBC-40/22	M10 - M16	1
FES-H-40/22-3050-HDG	552482	●	3,050	13	No	Round anchor	hot-dip galvanised	FBC-40/22	M10 - M16	1
FES-H-40/22-6070-HDG	552483	●	6,070	25	No	Round anchor	hot-dip galvanised	FBC-40/22	M10 - M16	1
FES-H-I-40/22-150-HDG	552507	●	150	2	No	I Anchor	hot-dip galvanised	FBC-40/22	M10 - M16	1
FES-H-I-40/22-200-HDG	552508	●	200	2	No	I Anchor	hot-dip galvanised	FBC-40/22	M10 - M16	1
FES-H-I-40/22-250-HDG	552509	●	250	2	No	I Anchor	hot-dip galvanised	FBC-40/22	M10 - M16	1
FES-H-I-40/22-300-HDG	552510	●	300	2	No	I Anchor	hot-dip galvanised	FBC-40/22	M10 - M16	1
FES-H-I-40/22-350-HDG	552511	●	350	3	No	I Anchor	hot-dip galvanised	FBC-40/22	M10 - M16	1
FES-H-I-40/22-400-HDG	552512	●	400	3	No	I Anchor	hot-dip galvanised	FBC-40/22	M10 - M16	1
FES-H-I-40/22-550-HDG	552513	●	550	3	No	I Anchor	hot-dip galvanised	FBC-40/22	M10 - M16	1
FES-H-I-40/22-1050-HDG	552514	●	1,050	5	No	I Anchor	hot-dip galvanised	FBC-40/22	M10 - M16	1
FES-H-I-40/22-6070-HDG	552515	●	6,070	25	No	I Anchor	hot-dip galvanised	FBC-40/22	M10 - M16	1

Technical data

Profile FES-H-50/30



FES-H

Item	Item no.	Approval ETA	Length l [mm]	Number of anchors	Serrated	Type	Coating	Match	Thread M	Sales unit [pcs]
FES-H-50/30-150-HDG	552484	●	150	2	No	Round anchor	hot-dip galvanised	FBC-50/30 / FBC-N-50/30	M10 - M20 for FBC-50/30 or M20 for FBC-N-50/30	1
FES-H-50/30-200-HDG	552485	●	200	2	No	Round anchor	hot-dip galvanised	FBC-50/30 / FBC-N-50/30	M10 - M20 for FBC-50/30 or M20 for FBC-N-50/30	1
FES-H-50/30-250-HDG	552486	●	250	2	No	Round anchor	hot-dip galvanised	FBC-50/30 / FBC-N-50/30	M10 - M20 for FBC-50/30 or M20 for FBC-N-50/30	1
FES-H-50/30-300-HDG	552487	●	300	2	No	Round anchor	hot-dip galvanised	FBC-50/30 / FBC-N-50/30	M10 - M20 for FBC-50/30 or M20 for FBC-N-50/30	1
FES-H-50/30-350-HDG	552488	●	350	3	No	Round anchor	hot-dip galvanised	FBC-50/30 / FBC-N-50/30	M10 - M20 for FBC-50/30 or M20 for FBC-N-50/30	1
FES-H-50/30-400-HDG	552489	●	400	3	No	Round anchor	hot-dip galvanised	FBC-50/30 / FBC-N-50/30	M10 - M20 for FBC-50/30 or M20 for FBC-N-50/30	1
FES-H-50/30-550-HDG	552490	●	550	3	No	Round anchor	hot-dip galvanised	FBC-50/30 / FBC-N-50/30	M10 - M20 for FBC-50/30 or M20 for FBC-N-50/30	1
FES-H-50/30-800-HDG	552492	●	800	4	No	Round anchor	hot-dip galvanised	FBC-50/30 / FBC-N-50/30	M10 - M20 for FBC-50/30 or M20 for FBC-N-50/30	1

Technical data

Profile FES-H-50/30



FES-H

Item	Item no.	Approval	Length	Number of anchors	Serrated	Type	Coating	Match	Thread	Sales unit
		ETA	l [mm]	l					M	
FES-H-50/30-1050-HDG	552493	●	1,050	5	No	Round anchor	hot-dip galvanised	FBC-50/30, FBC-N-50/30	M10 - M20 for FBC-50/30 or M20 for FBC-N-50/30	1
FES-H-50/30-3050-HDG	552494	●	3,050	13	No	Round anchor	hot-dip galvanised	FBC-50/30, FBC-N-50/30	M10 - M20 for FBC-50/30 or M20 for FBC-N-50/30	1
FES-H-50/30-6070-HDG	552495	●	6,070	25	No	Round anchor	hot-dip galvanised	FBC-50/30, FBC-N-50/30	M10 - M20 for FBC-50/30 or M20 for FBC-N-50/30	1
FES-H-I-50/30-150-HDG	552516	●	150	2	No	I-Anchor	hot-dip galvanised	FBC-50/30, FBC-N-50/30	M10 - M20 for FBC-50/30 or M20 for FBC-N-50/30	1
FES-H-I-50/30-200-HDG	552517	●	200	2	No	I-Anchor	hot-dip galvanised	FBC-50/30, FBC-N-50/30	M10 - M20 for FBC-50/30 or M20 for FBC-N-50/30	1
FES-H-I-50/30-250-HDG	552518	●	250	2	No	I-Anchor	hot-dip galvanised	FBC-50/30, FBC-N-50/30	M10 - M20 for FBC-50/30 or M20 for FBC-N-50/30	1
FES-H-I-50/30-300-HDG	552519	●	300	2	No	I-Anchor	hot-dip galvanised	FBC-50/30, FBC-N-50/30	M10 - M20 for FBC-50/30 or M20 for FBC-N-50/30	1
FES-H-I-50/30-350-HDG	552520	●	350	3	No	I-Anchor	hot-dip galvanised	FBC-50/30, FBC-N-50/30	M10 - M20 for FBC-50/30 or M20 for FBC-N-50/30	1
FES-H-I-50/30-400-HDG	552521	●	400	3	No	I-Anchor	hot-dip galvanised	FBC-50/30, FBC-N-50/30	M10 - M20 for FBC-50/30 or M20 for FBC-N-50/30	1
FES-H-I-50/30-550-HDG	552522	●	550	3	No	I-Anchor	hot-dip galvanised	FBC-50/30, FBC-N-50/30	M10 - M20 for FBC-50/30 or M20 for FBC-N-50/30	1
FES-H-I-50/30-1050-HDG	552523	●	1,050	5	No	I-Anchor	hot-dip galvanised	FBC-50/30, FBC-N-50/30	M10 - M20 for FBC-50/30 or M20 for FBC-N-50/30	1
FES-H-I-50/30-6070-HDG	552524	●	6,070	25	No	I-Anchor	hot-dip galvanised	FBC-50/30, FBC-N-50/30	M10 - M20 for FBC-50/30 or M20 for FBC-N-50/30	1

Technical data

Profile FES-H-52/34



FES-H

Item	Item no.	Approval	Length	Number of anchors	Serrated	Type	Coating	Match	Thread	Sales unit
		ETA	l [mm]	l					M	
FES-H-52/34-150-HDG	552496	●	150	2	No	Round anchor	hot-dip galvanised	FBC-50/30, FBC-N-50/30	M10 - M20 for FBC-50/30 or M20 for FBC-N-50/30	1
FES-H-52/34-200-HDG	552497	●	200	2	No	Round anchor	hot-dip galvanised	FBC-50/30, FBC-N-50/30	M10 - M20 for FBC-50/30 or M20 for FBC-N-50/30	1
FES-H-52/34-250-HDG	552498	●	250	2	No	Round anchor	hot-dip galvanised	FBC-50/30, FBC-N-50/30	M10 - M20 for FBC-50/30 or M20 for FBC-N-50/30	1
FES-H-52/34-300-HDG	552499	●	300	2	No	Round anchor	hot-dip galvanised	FBC-50/30, FBC-N-50/30	M10 - M20 for FBC-50/30 or M20 for FBC-N-50/30	1
FES-H-52/34-350-HDG	552500	●	350	3	No	Round anchor	hot-dip galvanised	FBC-50/30, FBC-N-50/30	M10 - M20 for FBC-50/30 or M20 for FBC-N-50/30	1
FES-H-52/34-400-HDG	552501	●	400	3	No	Round anchor	hot-dip galvanised	FBC-50/30, FBC-N-50/30	M10 - M20 for FBC-50/30 or M20 for FBC-N-50/30	1
FES-H-52/34-550-HDG	552502	●	550	3	No	Round anchor	hot-dip galvanised	FBC-50/30, FBC-N-50/30	M10 - M20 for FBC-50/30 or M20 for FBC-N-50/30	1
FES-H-52/34-800-HDG	552503	●	800	4	No	Round anchor	hot-dip galvanised	FBC-50/30, FBC-N-50/30	M10 - M20 for FBC-50/30 or M20 for FBC-N-50/30	1

Technical data

Profile FES-H-52/34



FES-H

Item	Item no.	Approval	Length	Number of anchors	Serrated	Type	Coating	Match	Thread	Sales unit
		ETA	l [mm]						M	[pcs]
FES-H-52/34-1050-HDG	552504	●	1,050	5	No	Round anchor	hot-dip galvanised	FBC-50/30, FBC-N-50/30	M10 - M20 for FBC-50/30 or M20 for FBC-N-50/30	1
FES-H-52/34-3050-HDG	552505	●	3,050	13	No	Round anchor	hot-dip galvanised	FBC-50/30, FBC-N-50/30	M10 - M20 for FBC-50/30 or M20 for FBC-N-50/30	1
FES-H-52/34-6070-HDG	552506	●	6,070	25	No	Round anchor	hot-dip galvanised	FBC-50/30, FBC-N-50/30	M10 - M20 for FBC-50/30 or M20 for FBC-N-50/30	1
FES-H-I-52/34-150-HDG	552525	●	150	2	No	I-Anchor	hot-dip galvanised	FBC-50/30, FBC-N-50/30	M10 - M20 for FBC-50/30 or M20 for FBC-N-50/30	1
FES-H-I-52/34-200-HDG	552526	●	200	2	No	I-Anchor	hot-dip galvanised	FBC-50/30, FBC-N-50/30	M10 - M20 for FBC-50/30 or M20 for FBC-N-50/30	1
FES-H-I-52/34-250-HDG	552527	●	250	2	No	I-Anchor	hot-dip galvanised	FBC-50/30, FBC-N-50/30	M10 - M20 for FBC-50/30 or M20 for FBC-N-50/30	1
FES-H-I-52/34-300-HDG	552528	●	300	2	No	I-Anchor	hot-dip galvanised	FBC-50/30, FBC-N-50/30	M10 - M20 for FBC-50/30 or M20 for FBC-N-50/30	1
FES-H-I-52/34-350-HDG	552529	●	350	3	No	I-Anchor	hot-dip galvanised	FBC-50/30, FBC-N-50/30	M10 - M20 for FBC-50/30 or M20 for FBC-N-50/30	1
FES-H-I-52/34-400-HDG	552530	●	400	3	No	I-Anchor	hot-dip galvanised	FBC-50/30, FBC-N-50/30	M10 - M20 for FBC-50/30 or M20 for FBC-N-50/30	1
FES-H-I-52/34-550-HDG	552531	●	550	3	No	I-Anchor	hot-dip galvanised	FBC-50/30, FBC-N-50/30	M10 - M20 for FBC-50/30 or M20 for FBC-N-50/30	1
FES-H-I-52/34-1050-HDG	552532	●	1,050	5	No	I-Anchor	hot-dip galvanised	FBC-50/30, FBC-N-50/30	M10 - M20 for FBC-50/30 or M20 for FBC-N-50/30	1
FES-H-I-52/34-6070-HDG	552533	●	6,070	25	No	I-Anchor	hot-dip galvanised	FBC-50/30, FBC-N-50/30	M10 - M20 for FBC-50/30 or M20 for FBC-N-50/30	1

2

Cast-in Channel FES-H-S

Hot-rolled and serrated for optimum strength and safety.

2



Airports

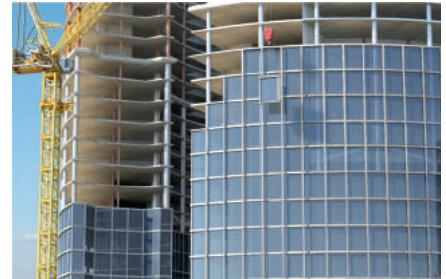

Unitised curtain wall

Applications

- Suitable for all types of buildings or structures
- Façades
- Prefabricated elements
- Railways
- Metro tunnels and stations
- Industrial applications

Advantages

- Hot-rolled Cast-in Channels combining optimum load capacity with high safety and flexibility.
- All directional load capacity. Excellent loading capacity in longitudinal direction in combination with FBC-S due to the full serration of the system.
- Ideal prepositioned fixing solution, capable of covering on-site tolerances.
- Suitable for applications in cracked and non-cracked concrete.
- Permanently adjustable fixing solution.

Approval



ETA-18/0862, FES with special screw FBC

Building materials

Concrete C12/15 to C90/105, cracked and non-cracked.

Functioning

Suitable for use in combination with serrated T-Bolts FBC-S.

Installation FES

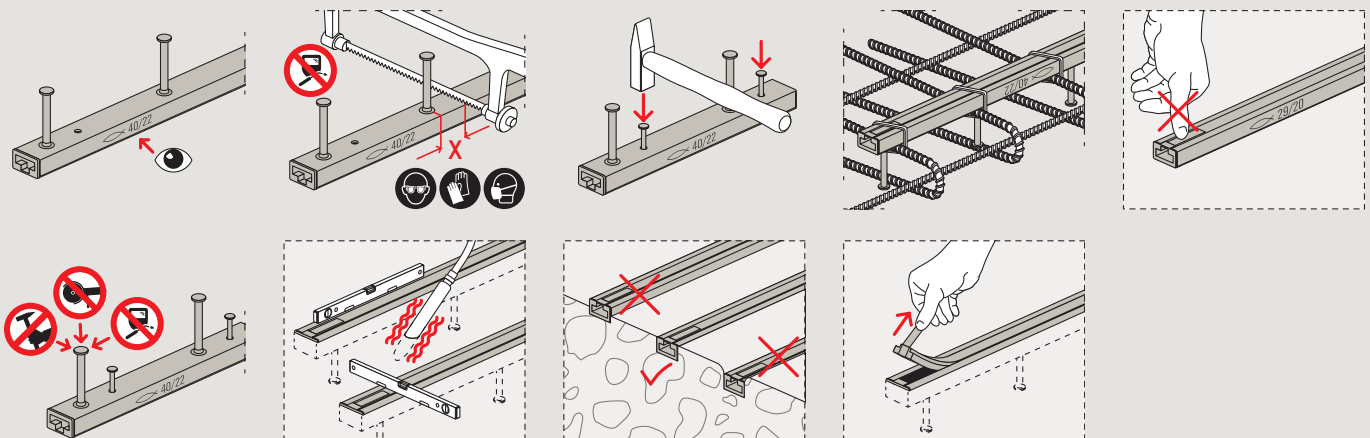

Technical data

Profile FES-H-S-29/20										
										
FES-H-S										
Item	Item no.	Approval ETA	Length l [mm]	Number of anchors	Serrated	Type	Coating	Match	Thread M	Sales unit [pcs]
FES-H-S-29/20-150-HDG	552446	●	150	2	Yes	Round anchor	hot-dip galvanised	FBC-S-29/20	M12	1
FES-H-S-29/20-200-HDG	552447	●	200	2	Yes	Round anchor	hot-dip galvanised	FBC-S-29/20	M12	1
FES-H-S-29/20-250-HDG	552448	●	250	2	Yes	Round anchor	hot-dip galvanised	FBC-S-29/20	M12	1
FES-H-S-29/20-300-HDG	552449	●	300	3	Yes	Round anchor	hot-dip galvanised	FBC-S-29/20	M12	1
FES-H-S-29/20-350-HDG	552450	●	350	3	Yes	Round anchor	hot-dip galvanised	FBC-S-29/20	M12	1
FES-H-S-29/20-400-HDG	552451	●	400	3	Yes	Round anchor	hot-dip galvanised	FBC-S-29/20	M12	1
FES-H-S-29/20-500-HDG	552452	●	500	4	Yes	Round anchor	hot-dip galvanised	FBC-S-29/20	M12	1
FES-H-S-29/20-850-HDG	552453	●	850	5	Yes	Round anchor	hot-dip galvanised	FBC-S-29/20	M12	1
FES-H-S-29/20-1050-HDG	552454	●	1,050	6	Yes	Round anchor	hot-dip galvanised	FBC-S-29/20	M12	1
FES-H-S-29/20-3050-HDG	552455	●	3,050	16	Yes	Round anchor	hot-dip galvanised	FBC-S-29/20	M12	1
FES-H-S-29/20-6070-HDG	552456	●	6,070	31	Yes	Round anchor	hot-dip galvanised	FBC-S-29/20	M12	1

Technical data

Profile FES-H-S-38/23										
										
FES-H-S										
Item	Item no.	Approval ETA	Length l [mm]	Number of anchors	Serrated	Type	Coating	Match	Thread M	Sales unit [pcs]
FES-H-S-38/23-150-HDG	552457	●	150	2	Yes	Round anchor	hot-dip galvanised	FBC-S-38/23	M12 - M16	1
FES-H-S-38/23-200-HDG	552458	●	200	2	Yes	Round anchor	hot-dip galvanised	FBC-S-38/23	M12 - M16	1
FES-H-S-38/23-250-HDG	552459	●	250	2	Yes	Round anchor	hot-dip galvanised	FBC-S-38/23	M12 - M16	1
FES-H-S-38/23-300-HDG	552460	●	300	2	Yes	Round anchor	hot-dip galvanised	FBC-S-38/23	M12 - M16	1
FES-H-S-38/23-350-HDG	552461	●	350	3	Yes	Round anchor	hot-dip galvanised	FBC-S-38/23	M12 - M16	1
FES-H-S-38/23-400-HDG	552462	●	400	3	Yes	Round anchor	hot-dip galvanised	FBC-S-38/23	M12 - M16	1
FES-H-S-38/23-550-HDG	552463	●	550	3	Yes	Round anchor	hot-dip galvanised	FBC-S-38/23	M12 - M16	1
FES-H-S-38/23-850-HDG	552464	●	850	5	Yes	Round anchor	hot-dip galvanised	FBC-S-38/23	M12 - M16	1
FES-H-S-38/23-1050-HDG	552465	●	1,050	5	Yes	Round anchor	hot-dip galvanised	FBC-S-38/23	M12 - M16	1
FES-H-S-38/23-3050-HDG	552466	●	3,050	13	Yes	Round anchor	hot-dip galvanised	FBC-S-38/23	M12 - M16	1
FES-H-S-38/23-6070-HDG	552467	●	6,070	25	Yes	Round anchor	hot-dip galvanised	FBC-S-38/23	M12 - M16	1

Installation instruction – Minimum edge distances and minimum bolt spacing

- For the installation of the Cast-In Channels the required edge distances, anchor and channel bolt spacings must be respected.
- fischer recommends the design software fixperience Channel-Fix for a safe and economical evaluation of load and on-site conditions.
- ETA values always have to be considered.

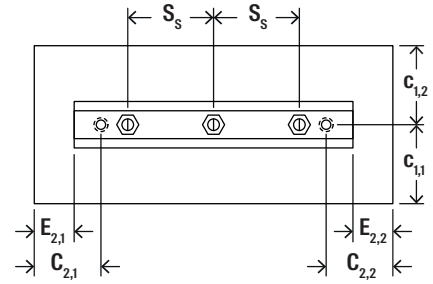
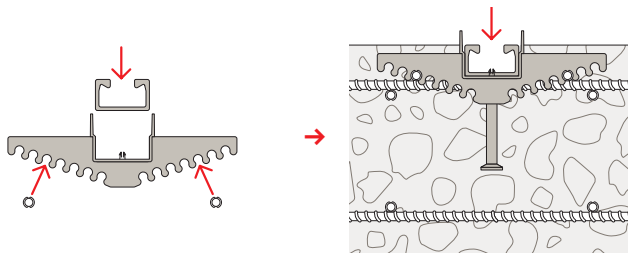

Figure: Minimum edge and bolt spacings

2

Profile	Thread M	Min. spacing $S_{s,min}$ [mm]	Min. edge sapcing $C_{1,min}$ [mm]	Min. edge spacing $C_{2,min}$ [mm]	Min. end spacing E_{min} [mm]
28/15	M8	40	40	40	15
28/15	M10	50	40	40	15
28/15	M12	60	40	40	15
38/17	M10	50	50	50	25
38/17	M12	60	50	50	25
38/17	M16	80	50	50	25
40/25	M12	60	50	50	25
40/25	M16	80	50	50	25
49/30	M12	60	75	75	50
49/30	M16	80	75	75	50
49/30	M20	100	75	75	50
54/33	M12	60	100	100	75
54/33	M16	80	100	100	75
54/33	M20	100	100	100	75

Channel inward installation options.



Attach the Cast-in Channel to the plastic clip

Attach the clip to the rebar

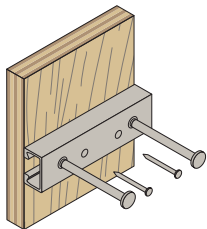

1. Nail fixing

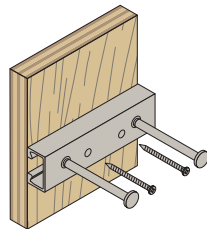

2. Self drilling screw fixing

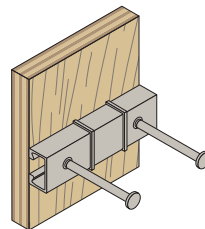



3. Clamp fixing



3

Channel bolts

Content

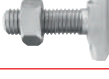
Channel bolt FBC	32	
Channel bolt FBC-N	37	
Channel bolt FBC-S	39	

Channel bolt FBC

Standard channel bolt strong, safe and flexible.

3



Pre-cast elements

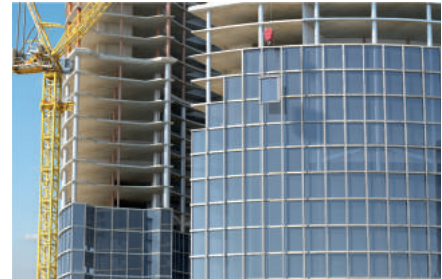

Unitised curtain wall

Applications

- Suitable for all types of buildings or structures
- Facçades
- Prefabricated elements
- Railways
- Metro tunnels and stations
- Industrial applications

Advantages

- FBC bolts with smooth underside fitting to Cast-in Channels with smooth channel lips.
- High load bearing capacity combined with flexibility.
- Two directional load capacity.

- Ideal prepositioned fixing solution, capable of covering on-site tolerances.
- Suitable for applications in cracked and non-cracked concrete.
- Permanently adjustable fixing solution.

Building materials

Concrete C12/15 to C90/105, cracked and non-cracked.

Functioning

- FBC channel bolts can be variably set in the planned position of Cast-in Channels.
- They are easily fixed by turning them 90° clockwise and then applying the specified torque moment.
- Suitable for use in combination with hot-rolled and cold-rolled fischer Cast-in Channels FES-C, FES-H and FES-H-S.

Installation FBC

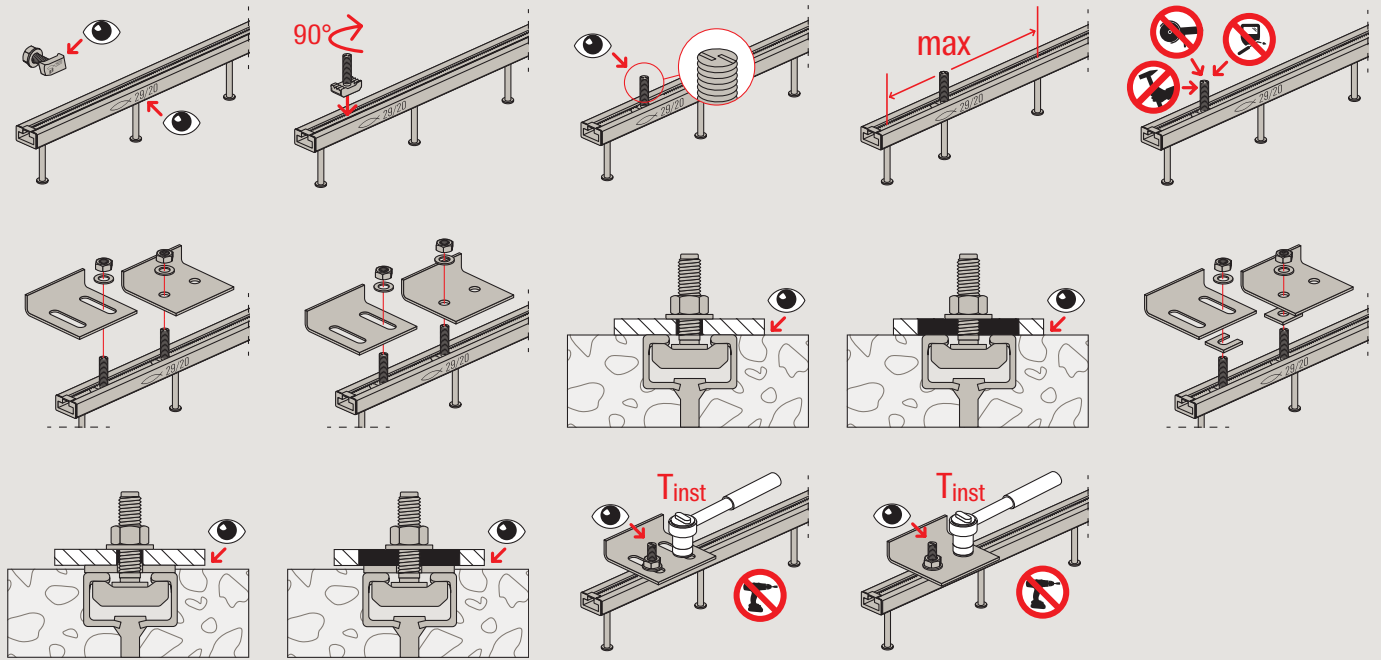

3

Technical data

Channel bolt FBC-28/15

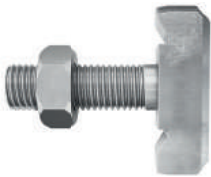

Bolt FBC

Item	Item no.	Thread	Length l [mm]	Material	Coating	Match	Sales unit [pcs]
FBC-28/15-M8x40-8.8-HDG	552600	M8	40	Steel grade 8.8	hot-dip galvanised	FES-C-28/15	270
FBC-28/15-M10x40-8.8-HDG	552604	M10	40	Steel grade 8.8	hot-dip galvanised	FES-C-28/15	240
FBC-28/15-M12x30-8.8-HDG	552605	M12	30	Steel grade 8.8	hot-dip galvanised	FES-C-28/15	210
FBC-28/15-M12x40-8.8-HDG	552606	M12	40	Steel grade 8.8	hot-dip galvanised	FES-C-28/15	180
FBC-28/15-M12x60-8.8-HDG	552607	M12	60	Steel grade 8.8	hot-dip galvanised	FES-C-28/15	180
FBC-28/15-M12x80-8.8-HDG	552609	M12	80	Steel grade 8.8	hot-dip galvanised	FES-C-28/15	150

Technical data

Channel bolt FBC-38/17

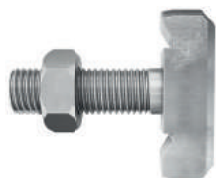

Bolt FBC

3

Item	Item no.	Thread M	Length l [mm]	Material	Coating	Match	Sales unit [pcs]
FBC-38/17-M10x30-8.8-HDG	552610	M10	30	Steel grade 8.8	hot-dip galvanised	FES-C-38/17	240
FBC-38/17-M10x40-8.8-HDG	552613	M10	40	Steel grade 8.8	hot-dip galvanised	FES-C-38/17	240
FBC-38/17-M10x60-8.8-HDG	552616	M10	60	Steel grade 8.8	hot-dip galvanised	FES-C-38/17	210
FBC-38/17-M10x80-8.8-HDG	552619	M10	80	Steel grade 8.8	hot-dip galvanised	FES-C-38/17	210
FBC-38/17-M12x40-8.8-HDG	552622	M12	40	Steel grade 8.8	hot-dip galvanised	FES-C-38/17	180
FBC-38/17-M12x60-8.8-HDG	552623	M12	60	Steel grade 8.8	hot-dip galvanised	FES-C-38/17	180
FBC-38/17-M12x80-8.8-HDG	552624	M12	80	Steel grade 8.8	hot-dip galvanised	FES-C-38/17	150
FBC-38/17-M16x50-8.8-HDG	552625	M16	50	Steel grade 8.8	hot-dip galvanised	FES-C-38/17	90
FBC-38/17-M16x80-8.8-HDG	552626	M16	80	Steel grade 8.8	hot-dip galvanised	FES-C-38/17	60

Technical data

Channel bolt FBC-40/22



Bolt FBC

Item	Item no.	Thread M	Length l [mm]	Material	Coating	Match	Sales unit [pcs]
FBC-40/22-M12x40-8.8-HDG	552627	M12	40	Steel grade 8.8	hot-dip galvanised	FES-H-40/22, FES-C-40/25	180
FBC-40/22-M12x50-8.8-HDG	552628	M12	50	Steel grade 8.8	hot-dip galvanised	FES-H-40/22, FES-C-40/25	180
FBC-40/22-M12x60-8.8-HDG	552629	M12	60	Steel grade 8.8	hot-dip galvanised	FES-H-40/22, FES-C-40/25	150
FBC-40/22-M12x80-8.8-HDG	552630	M12	80	Steel grade 8.8	hot-dip galvanised	FES-H-40/22, FES-C-40/25	120
FBC-40/22-M12x100-8.8-HDG	552637	M12	100	Steel grade 8.8	hot-dip galvanised	FES-H-40/22, FES-C-40/25	120
FBC-40/22-M16x50-8.8-HDG	552650	M16	50	Steel grade 8.8	hot-dip galvanised	FES-H-40/22, FES-C-40/25	60
FBC-40/22-M16x60-8.8-HDG	552655	M16	60	Steel grade 8.8	hot-dip galvanised	FES-H-40/22, FES-C-40/25	60
FBC-40/22-M16x80-8.8-HDG	552656	M16	80	Steel grade 8.8	hot-dip galvanised	FES-H-40/22, FES-C-40/25	60
FBC-40/22-M16x100-8.8-HDG	552657	M16	100	Steel grade 8.8	hot-dip galvanised	FES-H-40/22, FES-C-40/25	60

Technical data

Channel bolt FBC-50/30

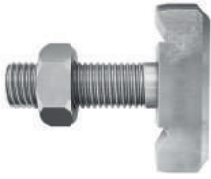

Bolt FBC

Item	Item no.	Thread M	Length l [mm]	Material	Coating	Match	Sales unit [pcs]
FBC-50/30-M12x40-8.8-HDG	552658	M12	40	Steel grade 8.8	hot-dip galvanised	FES-C-49/30, FES-H-50/30, FES-H-52/34, FES-C-54/33	180
FBC-50/30-M12x50-8.8-HDG	552659	M12	50	Steel grade 8.8	hot-dip galvanised	FES-C-49/30, FES-H-50/30, FES-H-52/34, FES-C-54/33	150
FBC-50/30-M12x60-8.8-HDG	552661	M12	60	Steel grade 8.8	hot-dip galvanised	FES-C-49/30, FES-H-50/30, FES-H-52/34, FES-C-54/33	150
FBC-50/30-M12x80-8.8-HDG	552663	M12	80	Steel grade 8.8	hot-dip galvanised	FES-C-49/30, FES-H-50/30, FES-H-52/34, FES-C-54/33	150
FBC-50/30-M12x100-8.8-HDG	552667	M16	100	Steel grade 8.8	hot-dip galvanised	FES-C-49/30, FES-H-50/30, FES-H-52/34, FES-C-54/33	120
FBC-50/30-M16x50-8.8-HDG	552669	M16	50	Steel grade 8.8	hot-dip galvanised	FES-C-49/30, FES-H-50/30, FES-H-52/34, FES-C-54/33	60
FBC-50/30-M16x60-8.8-HDG	552671	M16	60	Steel grade 8.8	hot-dip galvanised	FES-C-49/30, FES-H-50/30, FES-H-52/34, FES-C-54/33	60
FBC-50/30-M16x80-8.8-HDG	552673	M16	80	Steel grade 8.8	hot-dip galvanised	FES-C-49/30, FES-H-50/30, FES-H-52/34, FES-C-54/33	60
FBC-50/30-M16x100-8.8-HDG	552675	M16	100	Steel grade 8.8	hot-dip galvanised	FES-C-49/30, FES-H-50/30, FES-H-52/34, FES-C-54/33	60
FBC-50/30-M16x125-8.8-HDG	552676	M16	125	Steel grade 8.8	hot-dip galvanised	FES-C-49/30, FES-H-50/30, FES-H-52/34, FES-C-54/33	60
FBC-50/30-M20x60-8.8-HDG	552677	M20	60	Steel grade 8.8	hot-dip galvanised	FES-C-49/30, FES-H-50/30, FES-H-52/34, FES-C-54/33	30
FBC-50/30-M20x80-8.8-HDG	552678	M20	80	Steel grade 8.8	hot-dip galvanised	FES-C-49/30, FES-H-50/30, FES-H-52/34, FES-C-54/33	30
FBC-50/30-M20x100-8.8-HDG	552679	M20	100	Steel grade 8.8	hot-dip galvanised	FES-C-49/30, FES-H-50/30, FES-H-52/34, FES-C-54/33	30
FBC-50/30-M20x125-8.8-HDG	552684	M20	125	Steel grade 8.8	hot-dip galvanised	FES-C-49/30, FES-H-50/30, FES-H-52/34, FES-C-54/33	30
FBC-50/30-M20x200-8.8-HDG	552686	M20	200	Steel grade 8.8	hot-dip galvanised	FES-C-49/30, FES-H-50/30, FES-H-52/34, FES-C-54/33	30

Channel bolt design resistance

Standard channel bold FBC													
Profile	Strength class Steel grade	Load capacity M10			Load capacity M12			Load capacity M16			Load capacity M20		
		$N_{Rd,s}$ [kN]	$V_{Rd,s}$ [kN]	$M^0_{Rd,s}$ [kN]	$N_{Rd,s}$ [kN]	$V_{Rd,s}$ [kN]	$M^0_{Rd,s}$ [kN]	$N_{Rd,s}$ [kN]	$V_{Rd,s}$ [kN]	$M^0_{Rd,s}$ [kN]	$N_{Rd,s}$ [kN]	$V_{Rd,s}$ [kN]	$M^0_{Rd,s}$ [kN]
FBC-40/22	8.8	30.9	18.6	47.8	36.7	27.0	83.8	54.8	50.2	213.1	–	–	–
FBC-50/30	8.8	30.9	18.6	47.8	44.9	27.0	83.8	64.3	50.2	213.1	84.8	78.8	415.4

3 Required installation torque T_{inst}

Standard channel bold FBC			
Profile	Thread M	General (A) $T_{inst,g}$ [Nm]	Steel – steel contact (B) $T_{inst,s}$ [Nm]
	M12	25	45
	M16	50	100
FBC-50/30	M10	15	30
	M12	25	45
	M16	60	100
	M20	75	230

Channel bolt FBC-N

Notched channel bolt for excellent strength and safety.

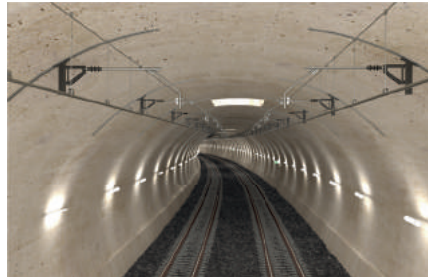

Railway tunnels

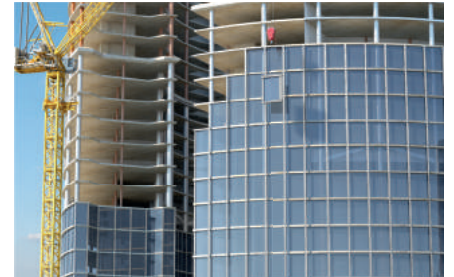

Unitised curtain wall

3

Applications

- Suitable for all types of buildings or structures
- Facçades
- Prefabricated elements
- Railways
- Metro tunnels and stations
- Industrial applications

Advantages

- FBC-N bolts with notched underside perfectly fitting to hot-rolled Cast-in channel lips.
- Thus giving excellent load capacity with high safety.
- All directional load capacity.
- Plus fundamental load capacity in longitudinal direction.

- Ideal prepositioned fixing solution, capable of covering on-site tolerances.
- Suitable for applications in cracked and non-cracked concrete.
- Permanently adjustable fixing solution.

Functioning

- FBC-N channel bolts can be variably set in the planned position of Cast-in Channels.
- They are easily fixed by turning them 90° clockwise and then applying the specified torque moment.
- Suitable for use in combination with hot rolled Cast-in Channels fischer FES-H.

Installation FBC

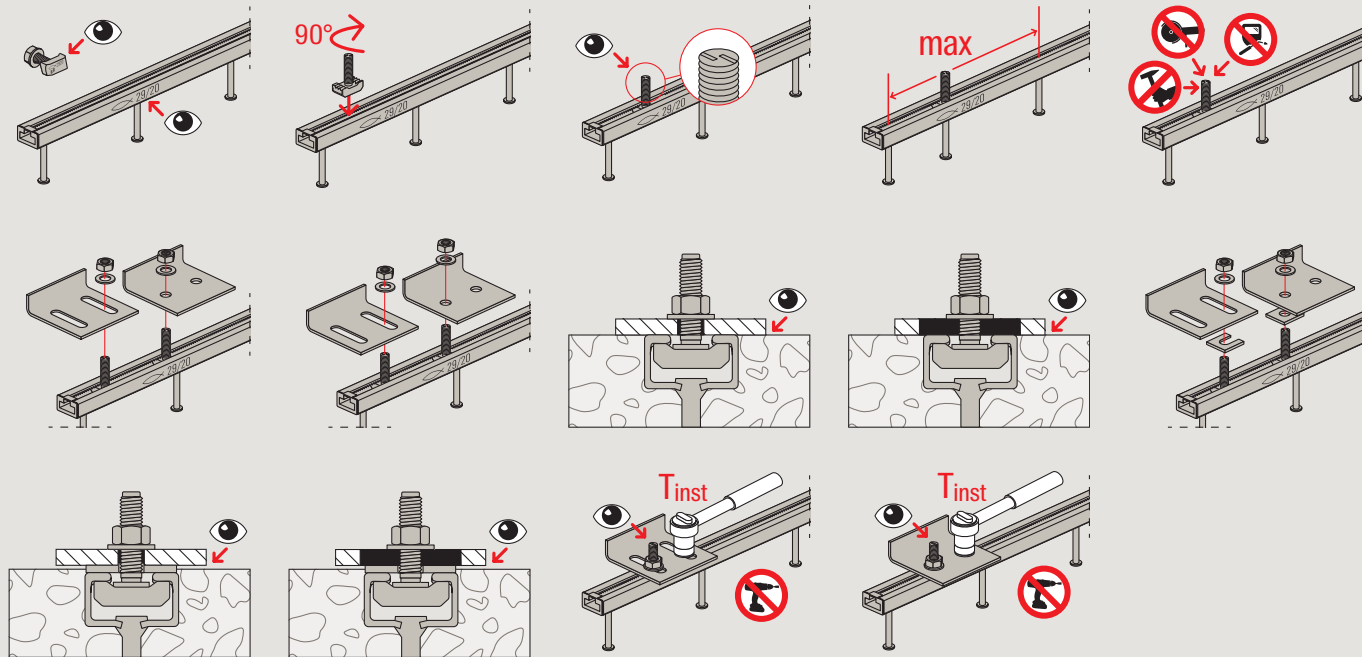

3

Technical data

Channel bolt FBC-N



Bolt FBC N

Item	Item no.	Thread M	Length l [mm]	Material	Coating	Match	Sales unit [pcs]
FBC-N-50/30-M20x60-8.8-HDG	552689	M20	60	Steel grade 8.8	hot-dip galvanised	FES-H-50/30, FES-H-52/34	30
FBC-N-50/30-M20x80-8.8-HDG	552690	M20	80	Steel grade 8.8	hot-dip galvanised	FES-H-50/30, FES-H-52/34	30
FBC-N-50/30-M20x100-8.8-HDG	552691	M20	100	Steel grade 8.8	hot-dip galvanised	FES-H-50/30, FES-H-52/34	30
FBC-N-50/30-M20x125-8.8-HDG	552693	M20	125	Steel grade 8.8	hot-dip galvanised	FES-H-50/30, FES-H-52/34	30
FBC-N-50/30-M20x200-8.8-HDG	552699	M20	200	Steel grade 8.8	hot-dip galvanised	FES-H-50/30, FES-H-52/34	30

Channel bolt design resistance

Standard channel bold FBC-N														
Profile	Strength class Steel grade	Load capacity M10			Load capacity M12			Load capacity M16			Load capacity M20			
		$N_{Rd,s}$ [kN]	$V_{Rd,s}$ [kN]	$M^0_{Rd,s}$ [Nm]	$N_{Rd,s}$ [kN]	$V_{Rd,s}$ [kN]	$M^0_{Rd,s}$ [Nm]	$N_{Rd,s}$ [kN]	$V_{Rd,s}$ [kN]	$M^0_{Rd,s}$ [Nm]	$N_{Rd,s}$ [kN]	$V_{Rd,s}$ [kN]	$M^0_{Rd,s}$ [Nm]	
FBC-N-50/30	8.8	-	-	-	-	-	-	-	-	-	95.0	78.4	415.4	

Required installation torque T_{inst}

Channel bold FBC-N				
Profile	Thread M	General (A)		Steel – steel contact (B)
		$T_{inst,g}$ [Nm]		$T_{inst,s}$ [Nm]
FBC-N-50/30	M20	-		400

Channel bolt FBC-S

Serrated channel bolt for optimum strength and safety.



Pre-cast elements

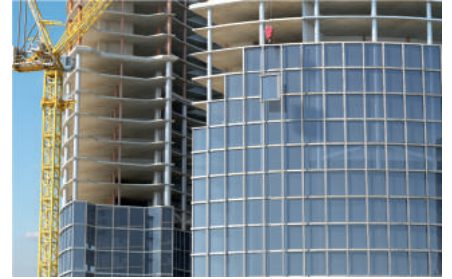

Unitised curtain wall

3

Applications

- Suitable for all types of buildings or structures
- Façades
- Prefabricated elements
- Railways
- Metro tunnels and stations
- Industrial applications

Advantages

- FBC-S bolts with serrated underside perfectly interlock with channels with serrated lips.
- Thus giving optimum load capacity with high safety.
- All directional load capacity.
- Plus optimum load capacity in longitudinal direction in combination with FES-H-S due to the full serration of the system.

- Ideal prepositioned fixing solution, capable of covering on-site tolerances.
- Suitable for applications in cracked and non-cracked concrete.
- Permanently adjustable fixing solution.

Building materials

Concrete C12/15 to C90/105, cracked and non-cracked.

Functioning

- FBC-S channel bolts can be variably set in the planned position of Cast-in Channels.
- They are easily fixed by turning them 90° clockwise and then applying the specified torque moment.
- Suitable for use in combination with hot-rolled and serrated Cast-in Channels fischer FES-H-S.

Installation FBC

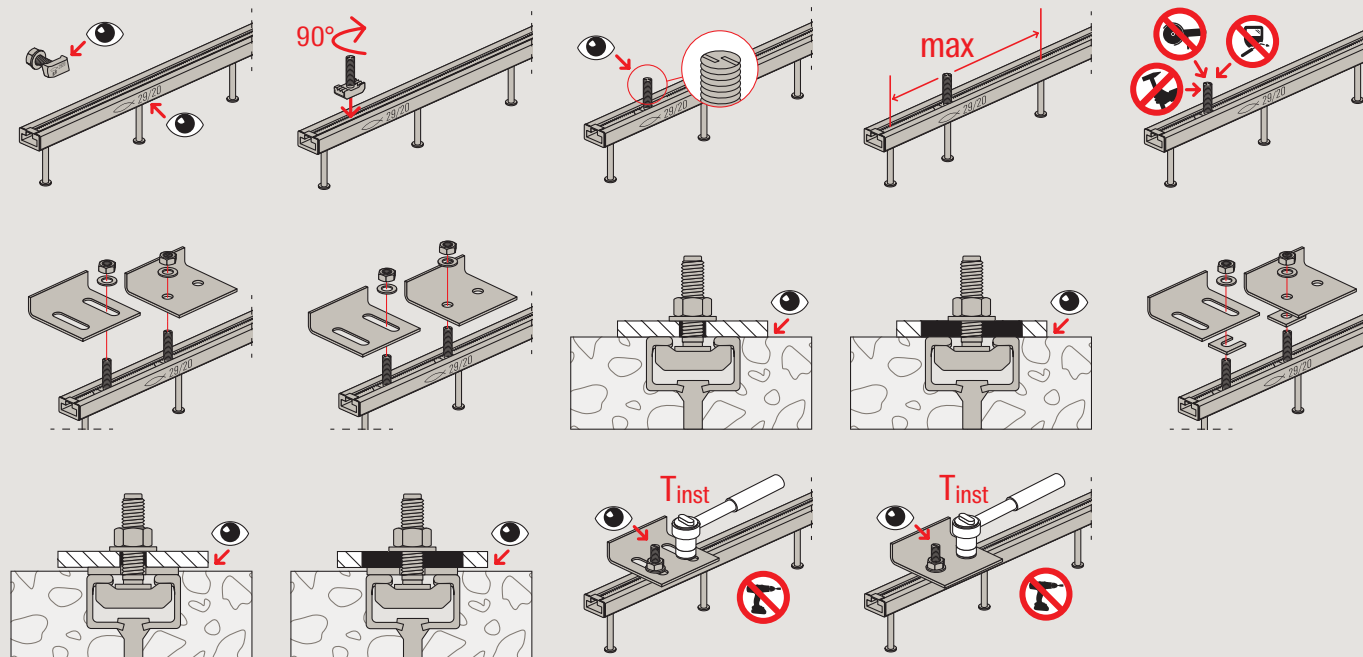

3

Technical data

Channel bolt FBC-S-29/20

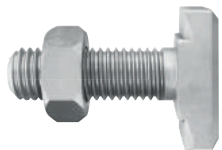

Bolt FBC S

Item	Item no.	Thread M	Length l [mm]	Material	Coating	Match	Sales unit [pcs]
FBC-S-29/20-M12x40-8.8-HDG	552700	M12	40	Steel grade 8.8	hot-dip galvanised	FES-H-S-29/20	180
FBC-S-29/20-M12x50-8.8-HDG	552704	M12	50	Steel grade 8.8	hot-dip galvanised	FES-H-S-29/20	150
FBC-S-29/20-M12x60-8.8-HDG	552705	M12	60	Steel grade 8.8	hot-dip galvanised	FES-H-S-29/20	150
FBC-S-29/20-M12x80-8.8-HDG	552711	M12	80	Steel grade 8.8	hot-dip galvanised	FES-H-S-29/20	150

Technical data

Channel bolt FBC-S-38/23

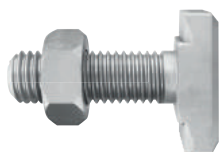

Bolt FBC S

Item	Item no.	Thread M	Length l [mm]	Material	Coating	Match	Sales unit [pcs]
FBC-S-38/23-M12x40-8.8-HDG	552712	M12	40	Steel grade 8.8	hot-dip galvanised	FES-H-S-38/23	150
FBC-S-38/23-M12x50-8.8-HDG	552713	M12	50	Steel grade 8.8	hot-dip galvanised	FES-H-S-38/23	150
FBC-S-38/23-M12x60-8.8-HDG	552714	M12	60	Steel grade 8.8	hot-dip galvanised	FES-H-S-38/23	120
FBC-S-38/23-M12x80-8.8-HDG	552718	M12	80	Steel grade 8.8	hot-dip galvanised	FES-H-S-38/23	120

Technical data

Channel bolt FBC-S-38/23

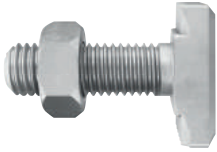

Bolt FBC S

Item	Item no.	Thread M	Length l [mm]	Material	Coating	Match	Sales unit [pcs]
FBC-S-38/23-M16x40-8.8-HDG	552719	M16	40	Steel grade 8.8	hot-dip galvanised	FES-H-S-38/23	60
FBC-S-38/23-M16x60-8.8-HDG	552720	M16	60	Steel grade 8.8	hot-dip galvanised	FES-H-S-38/23	60
FBC-S-38/23-M16x100-8.8-HDG	552721	M16	100	Steel grade 8.8	hot-dip galvanised	FES-H-S-38/23	60

Channel bolt design resistance

Standard channel bolt FBC-S

Profile	Strength class Steel grade	Load capacity M10			Load capacity M12			Load capacity M16			Load capacity M20		
		$N_{Rd,s}$ [kN]	$V_{Rd,s}$ [kN]	$M^0_{Rd,s}$ [kN]	$N_{Rd,s}$ [kN]	$V_{Rd,s}$ [kN]	$M^0_{Rd,s}$ [kN]	$N_{Rd,s}$ [kN]	$V_{Rd,s}$ [kN]	$M^0_{Rd,s}$ [kN]	$N_{Rd,s}$ [kN]	$V_{Rd,s}$ [kN]	$M^0_{Rd,s}$ [kN]
FBC-S-29/20	8.8	–	–	–	32,3	27,0	83,8	–	–	–	–	–	–
FBC-S-38/23	8.8	–	–	–	44,9	27,0	83,8	47,7	50,2	213,1	–	–	–

Required installation torque T_{inst}

Channel bolt FBC-S

Profile	Thread M	General (A)	Steel – steel contact (B)
		$T_{inst,g}$ [Nm]	$T_{inst,s}$ [Nm]
FBC-S-29/30	M12	80	80
FBC-S-38/23	M12	80	80
	M16	100	100

Channel bolt installation parameter

V_{min} /size	
Channel bolt thread	V_{min} [mm]
M10	14.5
M12	17
M16	20.5
M20	26

3

Cast-in Channel system lip thickness f	
Profile	Thickness [mm]
H-S-29/20	5.2
H-S-38/23	6
H-40/22	6.2
H-50/30	8.1
H-52/34	11.5
C-28/15	2.3
C-38/17	3.0
C-40/25	6.0
C-49/30	7.0
C-54/33	8.5

Figure: Channel bolt and channel lip dimensions

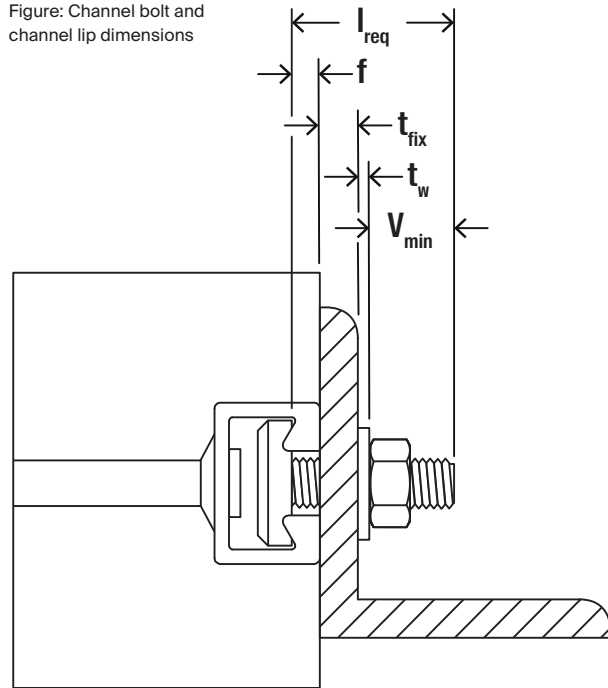

- l_{req} = required bolt length
- t_{fix} = thickness of clamped component
- f = profile lip thickness
- t_w = washer thickness
- V_{min} = nut height EN ISO 4032 + overhang approximately 5 mm (for M20: 7 mm)



4

Basics – good to know.

Content

Design method and approval	46
Anti-corrossion protection	46
Customised soitions	47
Failure mode	48
Software calculation methodology/process	50
Calculation examples	52
References	53

Design method and approval.



European Technical Assessment ETA-18/0862 of fischer Cast-in Channel Systems

The whole product portfolio is developed strictly following

- EN 1992-4 “Design of concrete structures - Part 4: Design of fastenings for use in concrete”
- EOTA TR047: Technical Report “Design of anchor channels” and combining with fischer renowned expertise in fastening technology

4

Anti-corrosion protection.



Hot-dip galvanised zinc coating

- Dipping the product in molten zinc pool to apply a metal zinc coating
- The usual approach of Cast in Channel for corrosion protection



Zinc-aluminum alloy coating

- Physically painted coating
- Better anticorrosion performance than hot-dip galvanised zinc

Customised solutions.

Curved Cast-in Channel Systems

For those high-demanding applications like tunnel construction, reinforced concrete utility tunnels, curved walls or sewage plants, fischer also provides curved Cast-in Channel System products as customised solution to meet your specific

requirements, as well as customised solution to meet you tailored needs in specific applications. These type of special products include curved channel, channel with rebar and others.

4

Channel inward installation

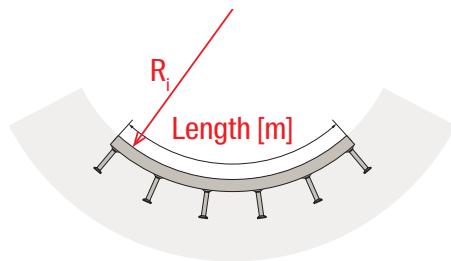

Channel outward installation

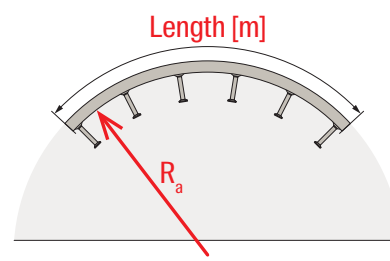

Minimum recommended bending radius for all materials

Minimum recommended bending radius for all materials



Type	Profile	R _i min [m]	R _a min [m]	Length min [m]	Length max [m]
Non-serrated hot-rolled	40/22	0.80	2.10	1.50	5.80
	50/30	0.80	2.10	1.50	5.80
	52/34	0.80	3.60	1.50	5.80
Serrated hot-rolled	29/20	0.55	1.80	0.50	5.80
	38/23	0.70	2.10	0.50	5.80

Under shear load acting parallel to the longitudinal channel axis

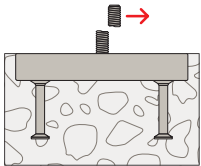

Steel channel bolt without lever arm

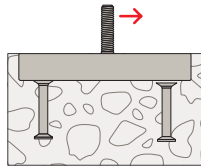

Steel connection between anchor and channel

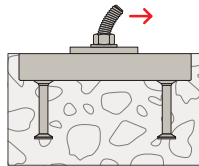

Steel channel bolt with lever arm

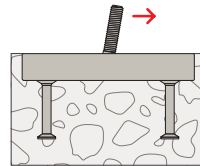

Steel connection between channel and channel bolt

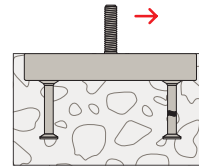

Steel anchor

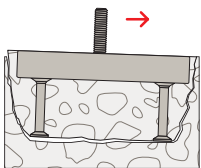

Concrete pry-out

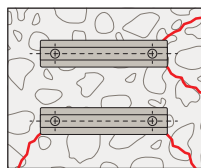

Concrete edge

Software calculation methodology/process.

4

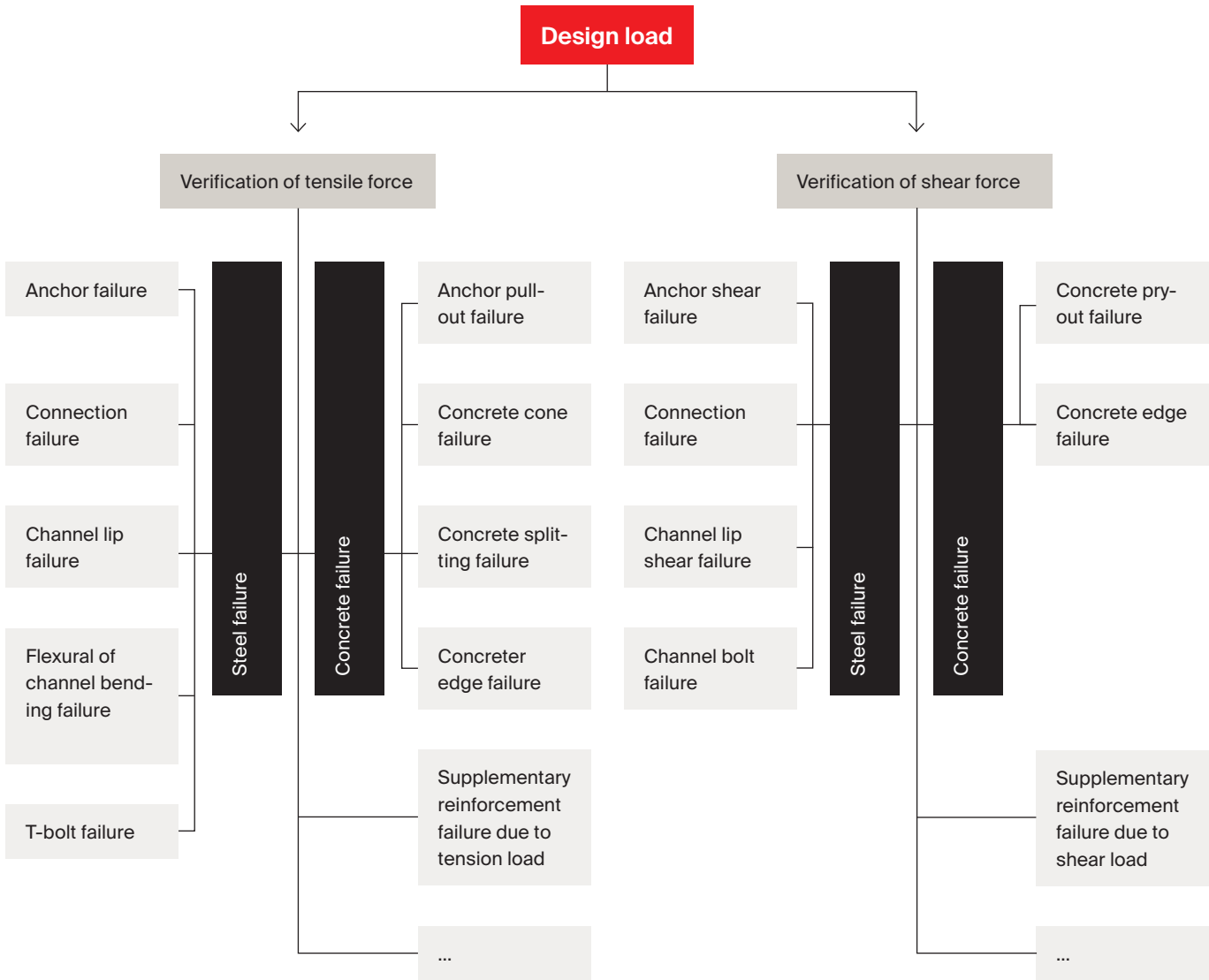

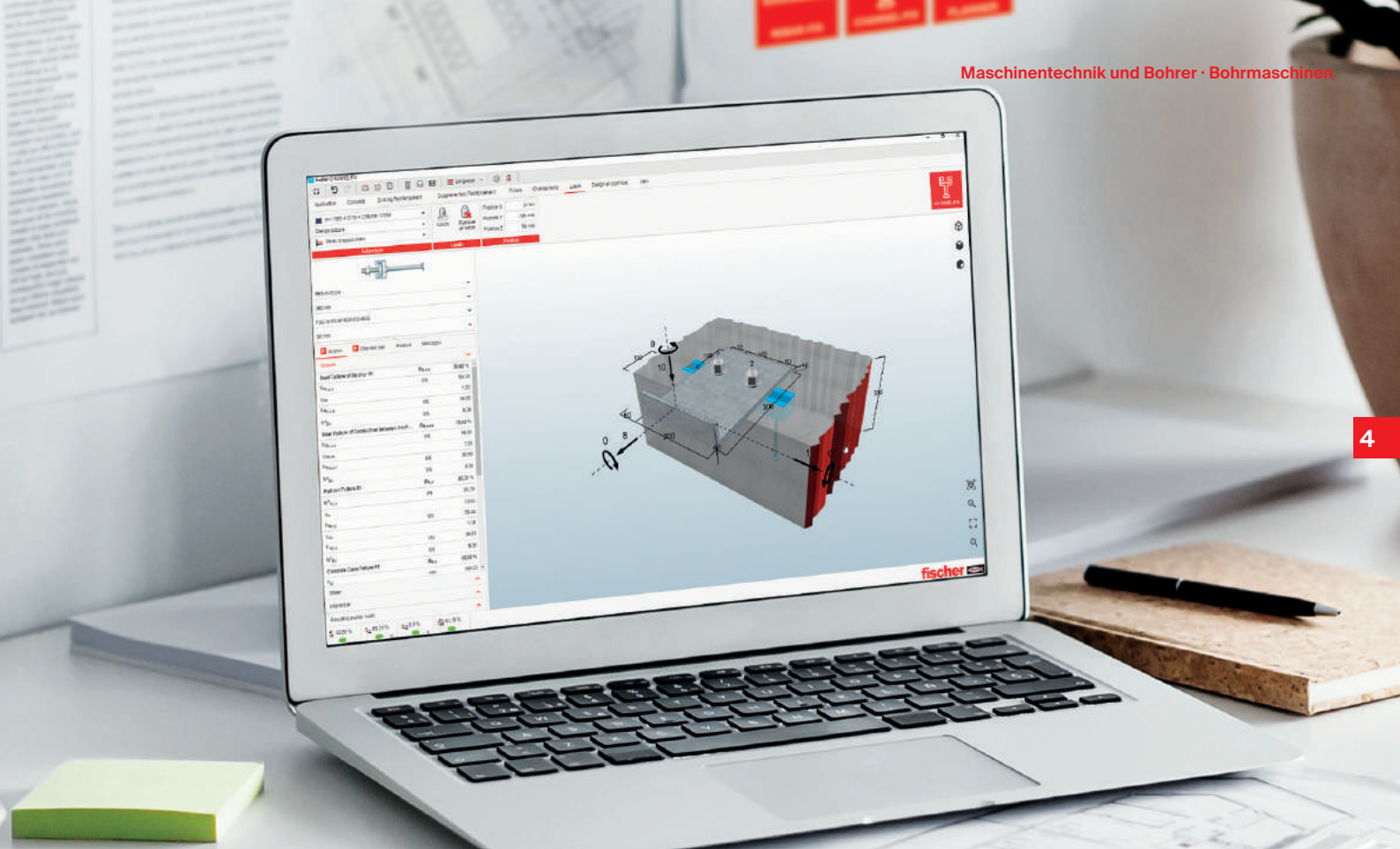

4

1. Channel system selection

2. Application

- Top of slab
- Front of slab

3. Concrete

- Concrete grade
- Concrete condition
- Concrete thickness
- Concrete cover
- Concrete chamfer

4. Reinforcement

- Area reinforcement
- Tensile reinforcement
- Shear reinforcement
- Reinforcement to control splitting

5. Fixture

- Simple fixture
- Rectangular plate
- Round plate
- L-shaped plates
- PI - shaped plate

6. Graphics

The 3D graphical interactive interface helps to simulate according to the parameter inputs. The display function supports rotation, zoom-in/out and other dynamic operation

· The Fischer Cast-in Channel Systems software embedded with multiple application expertise features friendly and reliable execution of verification for anchor channel cast in concrete structure, allowing you to model accurately and optimise about your specific fastening scenario.

· A variety of base materials, supplementary reinforcement, and loads can be applied. Additionally, different types of base plates and pre-defined brackets can be modeled. Results can be easily optimised and PDF reports can be generated in detailed or brief form for easy to follow verification including design formulas.

Calculation examples for Cast-in Channel Systems in curtain walls.

4

CHANNEL-FIX
1.0.25.0
Database version
1.0.25.0
Date
17.02.2022

Design specifications

Anchor channel
Anchor channel: FES-H-52/34-300-HDD
Article number: 552499
Channel bolt: FBC-N-50/30-M20x50-8.8-HDG
Article number: Available on request

Design data

Date: ETA-18/0862
16.06.2020

Input data

Design method: EN 1992-4 + CEN/TR 17080
Application: Top of slab
Concrete: C20/25, Cracked
Concrete thickness = 200 mm
Concrete cover = 25 mm
h_{ef} = 150 mm
h_{inst} = 158 mm

Area reinforcement: None
Tensile reinforcement: None
Shear reinforcement y: None

Shear reinforcement x

None

Reinforcement to control splitting

Yes

Fixture

L-Shaped Plate Up
Width = 200 mm
Depth = 300 mm
Thickness = 10 mm
Height = 50 mm

Stand-off

Distance = 0 mm
Degree of restraint = 2

Stand-off

Distance = 0 mm
Degree of restraint = 2

Anchor channel

FES-H-52/34, Length = 300 mm
Channel bolts

#	Position x
1	54 mm
2	160 mm

Sliding area

None sliding area

Loads

The input values and the design results should be checked against local valid standards and approvals. Please respect the disclaimer of warranty in the license agreement of the Software.

CHANNEL-FIX
1.0.25.0
Database version
1.0.25.0
Date
17.02.2022

Concrete Edge Failure - Channel Installed Parallel to the Edge - Anchor #1

$$V_{Ed,y} \leq \frac{V_{Rk,s,y}}{V_{Mc}} \quad (V_{Rk,s,y})$$

$$V_{Rk,s,y} = \sqrt{R_{k,c}} \cdot \psi_{ch,a,V} \cdot \psi_{ch,c,V} \cdot \psi_{ch,h,V} \cdot \psi_{ch,90^\circ,V} \cdot \psi_{s,V} \cdot V_{Mc} = 15,57 \text{ kN} \cdot 0,754 \cdot 1,000 \cdot 0,964 \cdot 1,000 \cdot 1,000 = 10,14 \text{ kN}$$

$$V_{Rk,c} = k_{12} \cdot \sqrt{f_{ct}} \cdot c_1^{\frac{2}{3}} = 7,5 \cdot \sqrt{20 \text{ N/mm}^2} \cdot 100 \text{ mm}^{\frac{2}{3}} = 15,57 \text{ kN}$$

$$\psi_{ch,a,V} = \min \left(\frac{1}{1 + \frac{a_{ch,V}}{s_j} \left(1 - \frac{s_j}{2a_{ch,V}} \right)^{1,5} \cdot \frac{V_{Ed,y}}{V_{Mc}}}, 1 \right) = \min \left(1, 1 \right) = 1$$

$$\psi_{ch,c,V} = \min \left(\frac{c_2}{c_{or,V}}, 1 \right)^{0,5} = \min \left(\frac{20 \text{ mm}}{253 \text{ mm}}, 1 \right)^{0,5} = 1,0$$

$$\psi_{ch,h,V} = \min \left(\frac{h}{h_{or,V}}, 1 \right)^{0,5} = \min \left(\frac{200 \text{ mm}}{268 \text{ mm}}, 1 \right)^{0,5} = 0,8$$

$$\psi_{ch,90^\circ,V} = 1,000$$

$$\psi_{s,V} = 1,000$$

V _{Ed,x}	V _{Ed,y}	V _{Ed,z}
30,14 kN	1,58	6,76 kN

Anchor #	β _{yk}
1	66,31 %
2	98,77 %

Acting Parallel to the Longitudinal Axis of the Channel

Proof

Steel Failure of Anchor - Anchor #1, #2
Steel Failure of Connection between Anchor and Channel - Anchor #1, #2
Concrete Pullout Failure in x-direction - Anchor #1, #2
Concrete Edge Failure - Channel Installed Parallel to the Edge - Anchor #1, #2

Steel Failure of Anchor - Anchor #1, #2

$$V_{Ed,x} \leq \frac{V_{Rk,s,x}}{V_{Mc}} \quad (V_{Rk,s,x})$$

V _{Ed,x}	V _{Ed,y}	V _{Ed,z}
33 kN	1,58	18,53 kN

Anchor #	β _{yk,x}
1	2,73 %
2	2,73 %

The input values and the design results should be checked against local valid standards and approvals. Please respect the disclaimer of warranty in the license agreement of the Software.

CHANNEL-FIX
1.0.25.0
Database version
1.0.25.0
Date
17.02.2022

Resistance to combined tensile and shear loads

Steel failure of anchor and connection between anchor and channel

$$\beta_{yk} = 30,62\% \text{ Anchor\#1}$$

$$\beta_{yk} = 2,73\% \text{ Anchor\#1,\#2}$$

$$\beta_{yk} = 7,95\% \text{ Anchor\#1}$$

$$(\beta_{yk})^{1,00} + (\beta_{yk})^{1,00} \leq (1 - \beta_{yk})^{1,00} ; (0,31)^{1,00} + (0,08)^{1,00} = 0,39 \leq (1 - 0,03)^{1,00} = 0,97 \text{ Anchor\#1}$$

Concrete failure modes

$$\beta_{yk} = 42,69\% \text{ Anchor\#1}$$

$$\beta_{yk} = 3,00\% \text{ Anchor\#1}$$

$$\beta_{yk} = 65,31\% \text{ Anchor\#1}$$

$$(\beta_{yk})^{1,50} + (\beta_{yk})^{1,50} + (\beta_{yk})^{1,50} = (0,43)^{1,50} + (0,03)^{1,50} + (0,65)^{1,50} = 0,81 \leq 1 \text{ Anchor\#1}$$

Steel failure of channel bolts

$$\beta_{yk} = 6,94\% \text{ Channelbolt\#1}$$

$$\beta_{yk} = 7,62\% \text{ Channelbolt\#1}$$

$$(\beta_{yk})^{2,00} + (\beta_{yk})^{2,00} = (0,10)^{2,00} + (0,08)^{2,00} = 0,02 \leq 1 \text{ Channelbolt\#1}$$

Steel failure of channel lips and flexural failure of channel

$$\beta_{yk} = 24,19\% \text{ Channelbolt\#1}$$

$$\beta_{yk} = 6,90\% \text{ Channelbolt\#1,\#2}$$

$$\beta_{yk} = 10,97\% \text{ Channelbolt\#1}$$

$$(\beta_{yk})^{1,00} + (\beta_{yk})^{1,00} \leq (1 - \beta_{yk})^{1,00} ; (0,24)^{1,00} + (0,11)^{1,00} = 0,35 \leq (1 - 0,07)^{1,00} = 0,93 \text{ Channelbolt\#1}$$



Proof successful

Technical remarks

All data and information in the software is based on fischer products and common engineering knowledge. Please check all the proof results against local valid standards and approvals. As fischer is not the design office, the attached is no guarantee for incorrect input or assumptions. Any recommendations have to be approved by the building authority or project engineer. Results are valid only for anchor system calculated in the attached. If any part of the system is changed, it will invalidate this report and new calculations would be required. The transmission of the loads to the supports of the concrete member shall be shown for the ultimate limit state and the serviceability limit state, for this purpose, the normal verifications shall be carried out under due consideration of the actions introduced by the anchors and bolts. For these verifications the additional provisions given in the current design method shall be taken into account. As a pre-condition the anchor plate is assumed to be flat when subjected to the actions. Therefore, the plate must be sufficiently stiff. The proof of the necessary stiffness is not carried out by Channel-Fix. The design for the shear forces acting parallel to the anchor channel are performed via CEN/TR 17080 as there is absence of any related part in EN1992-4.

The input values and the design results should be checked against local valid standards and approvals. Please respect the disclaimer of warranty in the license agreement of the Software.

References



Central Bank Turkey · Istanbul · Turkey

1. Changchun Longxiang- business center · Changchun · China
2. Guiyang Financial Center building · Guiyang · China
3. Baoding Healthy city · Baoding · China
4. Hangzhou Xiasha Marriott hotel · Hangzhou · China
5. Wuxi Hanglung Plaza Wuxi · China
6. Dali East sea developing zone Utility tunnel · Dali · China
7. Chengdu Global Foundrie · Chengdu · China
8. Shanghai Yoozoo Plaza · Shanghai · China
9. Zhengzhou Media Group Mansion · Zhengzhou · China
10. Tianjing Utility Tunnel · Tianjing · China
11. Zhengzhou Zhengshang International Building · Zhengzhou · China
12. Chengdu Tianfu Airport City Pipeline Terminal · Chengdu · China
13. Shenzhen Fuji Land Building 1# Building · Shenzhen · China
14. Hangzhou Joy City · Hangzhou · China
15. Guizhou Anshun Urban Construction Building · Guizhou · China
16. Central Bank Turkey · Istanbul · Turkey
17. Dubai Hills Mall Roller Coaster · Dubai · U.A.E.
18. Nest One · Tashkent · Uzbekistan
19. Quartier Puerto Retiro · Buenos Aires · Argentina



5 Service

Content

Property and construction site management	56
Planner and structural engineers	57
Portfolio	58
fischer subsidiaries	60



5

Intensive support. fischer advises on your construction site.

fischer field specialists

- We support our customers on site at the construction site. We advise and help to fasten everything professionally. Tensile tests and fastening tests on site provide additional safety.
- Target-oriented not only in terms of safety: Together with our customers, we work out fastening solutions on site that are effective and economical. The installation procedures are optimised taking into account the general progress of the construction site.
- The training offered for customers and their employees provides targeted support for daily applications and imparts specialised knowledge.

fischer specialists on the technical hotline

- The same applies on the phone: the engineers and technicians who answer the questions have many years of practical experience and know how to correctly assess the trade-specific requirements.
- We are reliable contacts for our customers on the phone when it comes to building materials, loads, anchor dimensions, anchoring topics, approvals or the design of connecting parts.
- Major projects require fastening know-how to a particularly high degree. On request, one of the fischer experts can become a permanent part of the construction site management team.

Your contact for technical advice

International Technical Support
intsupport@fischer.de

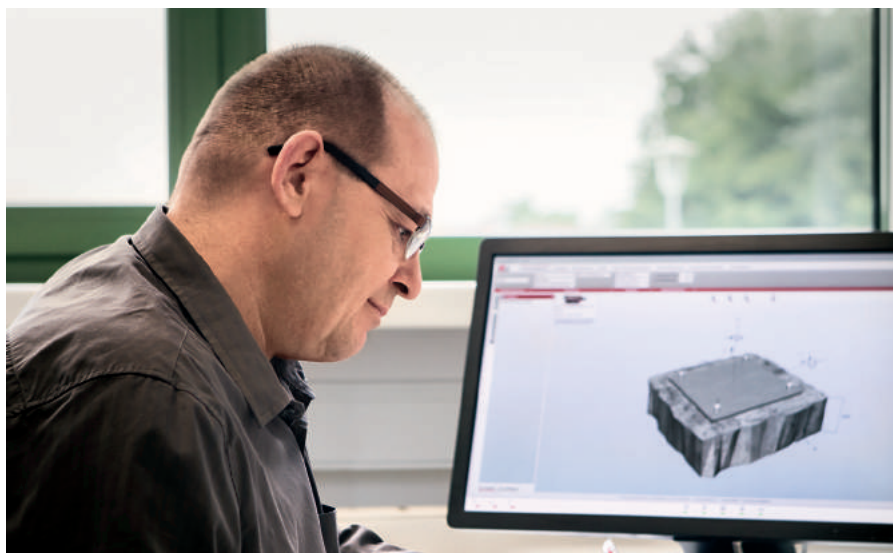

fischer competence. This makes for solid planning.

The permanent fixture for planners and structural engineers

- We support planners and structural engineers to effectively save time and costs which has an impact on all phases of construction.
- Ideally, cooperation begins in the preliminary phase, for example in the economic optimisation of anchoring constructions, in the dimensioning of special constructions and in sample dimensioning.
- The tried-and-tested fischer FiXperience software is a standard tool in many planning offices.

Solution competence for particularly difficult cases

- We provide effective help when existing anchorages have not been executed according to plan or regulations.
- Even if the anchoring base does not conform to the approval, we will find a safe and reliable solution.

Your contact for technical advice

International Technical Support
intsupport@fischer.de

Main catalogue fixing systems.

Products for use in fixing technology.

The fixing catalogue offers many facts and helps with quick and safe product selection, e.g.:

- Produktbeschreibungen mit Vorteile/Nutzen im Überblick
- Tips for installation
- Application aids
- Detailed technical data and drawings
- Basics of fastening technology
- All you need to know about professional fixing

5



Order now: info@fischer.com

Main catalogue FireStop.

Products for use in passive fire protection.

The FireStop catalogue offers many facts and helps with fast and safe product selection, e.g.:

- Basics of passive fire protection
- Product and system presentations
- Application aids
- Detailed technical data and drawings



Order now: info@fischer.com

Main catalogue Installation Systems.

Products for use in installation technology.

Many facts about the products and everything you need to know about fischer installation systems, e.g.:

- Product- and system introductions
- Plugs and anchors for fixing the system components
- Application aids
- Detailed technical data and drawings
- Basics of installation technology

Order now: info@fischer.com



5

Main catalogue Façade Systems.

All facts about the fischer façade range and its applications.

The Façade Systems catalogue offers many facts and helps with quick and safe product selection, e.g.:

- Presentation of Zykon panel anchor, machine technology, drill bits, subframes, general fixing products and accessories with detailed technical data and illustrations.
- Application support.
- Basic knowledge about undercut anchors and subframe systems.
- Available design software

Order now: info@fischer.com



Germany

fischer Deutschland Vertriebs GmbH
Klaus-Fischer-Straße 1
72178 Waldachtal
P +49 7443 12 - 6000
F +49 7443 12 - 4500
info@fischer.de
www.fischer.de

Argentina

fischer Argentina s.a.
Armenia 3044
1605 Munro Ra-PCIA Buenos Aires
P +54 1147 62 27 78
F +54 1147 56 13 11
asistenciatecnica@fischer.com.ar
www.fischer.com.ar

Austria

fischer Austria GmbH
Wiener Straße 95
2514 Traiskirchen
P +43 2252 53730 0
F +43 2252 53730 70
office@fischer.at
www.fischer.at

Belgium

fischer Cobemabel snc
Schaliënhoevedreef 20 D
2800 Mechelen
P +32 152 8 47 00
F +32 152 8 47 10
info@fischer.be
www.fischer.be

Brazil

fischer brasil Industria e Comercio Ltda.
Estrada do Dende, 300 Ilha do Governador
21920-001 Rio de Janeiro-RJ
P +55 21 2467 11 30
F +55 21 2467 01 44
fischer@fischerbrasil.com.br
www.fischerbrasil.com.br

China

fischer (Taicang) fixings Co. Ltd.
No. 17, Lane 166, Guchuan Road, 14th
Floor, Building 2, Zhongjun Tianyue Center
200333 Shanghai
P +86 21 51 00 16 68
F +86 21 65 97 96 22
ficn@fischer.com.cn
www.fischer.com.cn

Czech Republic

fischer international s.r.o.
Průmyslová 1833
25001 Brandýs nad Labem
P +42 03 26 90 46 01
F +42 03 26 90 46 00
info@fischer-cz.cz
www.fischer-cz.cz

Denmark

fischer a/s
Sandvadsvej 17 A
4600 Køge
P +45 46 32 02 20
F +45 46 32 50 52
fidk@fischerdenmark.dk
www.fischerdenmark.dk

Finland

fischer Finland Oy
Suomalaistentie 7 B
02270 Espoo
P +358 20 741 46 60
F +358 20 741 46 69
orders@fischerfinland.fi
www.fischerfinland.fi

France

fischer S. A. S.
12, rue Livio, P. O. Box 10182
67022 Strasbourg-Cedex 1
P +33 388 39 18 67
F +33 388 39 80 44
info@fischer.fr
www.fischer.fr

Greece

fischer Hellas
Kalavriton 2 & Kaiafa
14564 Kifissia, Athens
P +30 21 02 83 81 67
F +30 21 02 83 81 69
info@fischer.gr
www.fischer.gr

Hungary

fischer Hungária Bt.
Szerémi út 7/b
1117 Budapest
P +36 1 347 97 55
F +36 1 347 97 66
info@fischerhungary.hu
www.fischerhungary.hu

India

fischer BUILDING MATERIAL INDIA PVT LTD.
PRESTIGE GARNET UNIT NO- 401,
4TH FLOOR 36, ULSOOR ROAD
560042 Bangalore KARNATAKA
P +91 0804 1511 991 92 93
F +91 0804 1511 989
info@fischer.in
www.fischer.in

Italy

fischer italia S.R.L
Corso Stati Uniti, 25, Casella Postale 391
35127 Padova Z.I. Sud
P +39 049 8 06 31 11
F +39 049 8 06 34 01
sercli@fischeritalia.it
www.fischeritalia.it

Japan

fischer Japan K.K.
Pronte Kudan Building 3rd Floor 3-4-15
Kudan Minami Chiyoda-ku, 102-0074 Tokyo
P +81 33 26 34 49 1
F +81 36 27 29 93 5
info@fischerjapan.co.jp
www.fischerjapan.co.jp

Korea, Republic

fischer Korea Co., Ltd (fiker)
Room 601/602, Kolon Digital Billant 30,
Digitalro 32-Gil, Guro-Gu, Seoul,
Korea 08390
P +82 1544 89 55
F +82 1544 89 03
info@fischerkorea.com
www.fischerkorea.com

Mexico

fischer Sistemas de Fijación, S.A. de C.V.
Blvd. Manuel Avila Camacho 3130-400B
54020 Col. Valle Dorado, Tlalnepantla
P +52 55 55 72 08 83
F +52 55 55 72 15 90
info@fischermex.com.mx
www.fischermex.com.mx

Netherlands

fischer Benelux B.V.
Gooimeer 14
1411 DE Naarden
P +31 35 6 95 66 66
F +31 35 6 95 66 99
info@fischer.nl
www.fischer.nl

Norway

fischer Norge AS
 Oluf Onsumsvei 9
 0680 Oslo
 P +47 23 24 27 10
 F +47 23 24 27 13
 ordre@fischernorge.no
 www.fischernorge.no

Philippines

fischer PH Asia, Inc.
 No 100 Congressional Avenue, Project 8
 1106 Quezon City
 P +63 2426 0888 217
 F +63 2880 3256
 joselito.ladlad@fischerph.com
 www.fischer.ph

Poland

fischerpolska Sp.z o.o
 ul. Albatrosow 2
 30-716 Kraków
 P +48 12 2 90 08 80
 F +48 12 2 90 08 88
 info@fischerpolska.pl
 www.fischerpolska.pl

Portugal

fischerwerke Portugal, Lda.
 Rua das Musas, Passeio dos Cruzados
 Lote 2.01 (Bloco3), Loja 8 (01.D) / Parque
 das Nações, 1990-171 Lisboa
 P +351 218 954 180
 F +351 218 967 066
 fischerportugal.info@fischer.pt
 www.fischer.pt

Qatar

fischer fasteners QD Trading LLC
 HUB Business Center, Barwa Commercial
 Avenue, Arkan Building, Block No. 4, Office
 No. 56, Building No 115, Street 964, Zone
 56, P. O. Box – 35190 Doha
 enquiry@fischer.qa
 www.fischer.qa

Romania

fischer fixings Romania S.R.L.
 Strada Oradiei, Nr. 1-3-5-7
 400220 Cluj Napoca, Judetul Cluj
 P +40 264 455 166
 F +40 264 403 060
 zoltan.kovacs@fischer.com.ro
 www.fischer.com.ro

Russian Federation

OOO fischer Befestigungssysteme Rus
 Leningradskoe shosse, 47, Bldg. 2, 2nd
 floor, apt. VI, 125195 Moscow
 P +7 495 223 61 62
 F +7 495 223 03 34
 info@fischerfixing.ru
 www.fischerfixing.ru

Singapore

fischer systems Asia Pte. Ltd.
 4 Kaki Bukit Avenue 1, #01-06
 417939 Singapore
 P +65 6741 0480
 F +65 6741 0481
 sales@fischer.sg
 www.fischer.sg

Slovakia

fischer S.K. s.r.o.
 Nová Rožňavská 134 A
 831 04 Bratislava
 P +421 2 4920 60 46
 F +421 2 4920 60 44
 info@fischerwerke.sk
 www.fischer-sk.sk

Spain

fischer Ibérica S.A.U.
 Klaus Fischer 1
 43300 Mont-Roig del Camp Tarragona
 P +34 977 83 87 11
 F +34 977 83 87 70
 servicio.cliente@fischer.es
 www.fischer.es

Sweden

fischer Sverige AB
 Nygatan 93
 602 34 Norrköping
 P +46 11 31 44 50
 info@fischersverige.se
 www.fischersverige.se

Turkey

fischer Metal Sanayi Ve Ticaret Ltd Sti
 Cevizli Mahallesi, Mustafa Kemal Paşa Cad.
 Seyit Gazi Sok. No 66, Hukukçular Towers A
 Blok, 34865 Kartal İstanbul
 P +90 216 326 00 66
 F +90 216 326 00 18
 info@fischer.com.tr
 www.fischer.com.tr

United Arab Emirates

fischer FZE
 R/A 07, BA - 04, Jebel Ali Free Zone
 Dubai
 P +97 14 8 83 74 77
 F +97 14 8 83 74 76
 enquiry@fischer.ae
 www.fischer.ae

United Kingdom

fischer fixings UK Ltd.
 Whitely Road
 Oxon OX10 9AT Wallingford
 P +44 1491 82 79 00
 F +44 1491 82 79 53
 info@fischer.co.uk
 www.fischer.co.uk

United States

fischer fixings LLC (fius)
 205 US HWY 46, Suite 4 07512 Totowa,
 New Jersey
 P +1 973 256 30 45
 F +1 845 625 26 66
 sales@fischerus.net
 www.fischerfixings.com

Vietnam

**fischer production Company Limited –
 Tay Ninh Branch**
 Lot 36-23-B, 36-24, D14A Road, Phuoc
 Dong Industrial Park, Phuoc Dong
 Commune, Go Dau District, Tay Ninh
 Province
 info@fischer.vn

The information in this catalogue is intended for general guidance only and is given without engagement. Additional information and advice on specific applications is available from our Technical Support Team. For this however, we require a precise description of your particular application.

All the data in this catalogue concerning work with our fixing elements must be adapted to suit local conditions and the type of materials in use.

If no detailed performance specifications are given for certain articles and types, please contact our Technical Service Department for advice.

fischerwerke GmbH & Co. KG
72178 Waldachtal
Germany

We cannot be responsible for any errors, and we reserve the right to make technical and range modifications without notice.

No liability is accepted for printing errors and omissions.

www.fischer-international.com



fischer stands for

Fixing Systems
Automotive
fischertechnik
Consulting
Electronic Solutions

fischerwerke GmbH & Co. KG
Klaus-Fischer-Straße 1 · 72178 Waldachtal
Germany
P +49 7443 12 - 0 · F +49 7443 12 - 8297
www.fischer-international.com · intsupport@fischer.de

